



MODELS LF6 & LJ6 LEVEE PLOW

OPERATION – MAINTENANCE SET-UP INSTRUCTION



AMCO MANUFACTURING COMPANY

800 South Industrial Parkway P.O. Box 1107
Yazoo City, Mississippi (MS) 39194 USA
(662) 746-4464 Toll free 800-748-9022 Fax (662) 746-6825
www.amcomfg.com

TO THE PURCHASER

The care you give your new AMCO Levee Plow will greatly determine the satisfaction and service you will obtain from it. By observing the instructions and suggestions in this manual, your AMCO Levee Plow will serve you well for many years.

As an Authorized Dealer, we stock Genuine AMCO Parts, which are manufactured with the same precision and skill as the original equipment. For best performance and longer life use only Genuine AMCO replacement parts. Our factory trained staff is kept fully informed of the most efficient methods of servicing AMCO equipment and is ready and able to assist you.

When you sell your Plow you should pass this manual to the new owner.

If you should require additional aid or information, contact us.

YOUR AUTHORIZED AMCO DEALER

OSHA requires that as a farm employer you meet certain safety requirements. Become familiar with and comply with those requirements. Be sure anyone who operates this equipment understands all safety related items. If this harrow is repainted, be certain new decals are ordered. Decals pertaining to personal safety must be replaced.



Look for this symbol to point out important safety precautions. It means — **ATTENTION!** Become alert! Your safety is involved.

To insure efficient and prompt service, please provide the model number and serial number of your AMCO Plow in all correspondence or contacts. Remember, the right and left hand sides of the plow are determined by standing at the rear of the plow and facing the direction of travel.

MODEL NUMBER

SERIAL NUMBER



AMCO MANUFACTURING COMPANY

800 South Industrial Parkway P.O. Box 1107
Yazoo City, Mississippi (MS) 39194 USA
(662) 746-4464 Toll free 800-748-9022 Fax (662) 746-6825
www.amcomfg.com

SERVICE BULLETIN

On all models of Levee Plows when reversing gangs to tear down levees, bearing wear guard must be reversed also. If not reversed, material will build up between bearing and guard causing breaking off of guard and possible damage to bearing riser.

AMCO MANUFACTURING COMPANY

TABLE OF CONTENTS

To the Purchaser.....	i
Table of Contents.....	1
General Torque Table.....	2
Standard of Specifications.....	3

PARTS LIST

Main Frame	4
Main Frame	6
Hydraulic Circuit.....	8
Hydraulic Cylinder 3" x 8".....	10
Hydraulic Cylinder 3-1/4" x 8".....	12
8 Blade Gang and Frame.....	14
10 Blade Gang and Frame.....	16
Feathering Blades [Optional].....	18
Decals.....	19





OPERATIONS MANUAL

Safety Symbols.....	20
Assembly Instructions.....	21
Lubrication.....	24
Storage.....	25
Maintenance.....	26
Operating Instructions.....	27
Levee Construction.....	29
Levee Tear-Down Instructions.....	29
Operating Tips.....	32
Disk Blade Failures.....	33

Rev 2/21/12

GENERAL TORQUE SPECIFICATION TABLE

ALL BOLTS SHOULD BE TIGHTENED TO THE
RECOMMENDED TORQUES SHOWN IN THE
"GENERAL TORQUE SPECIFICATION TABLE"

GENERAL TORQUE SPECIFICATION TABLE				
USE THE FOLLOWING TORQUES WHEN SPECIAL TORQUES ARE NOT GIVEN				
<p>Note: These values apply to fasteners as received from supplier, dry, or when lubricated with normal engine oil. They do not apply if special graphited or moly-disulphide greases or other extreme pressure lubricants are used. This applies to both UNF and UNC threads.</p>				
SAE Grade No		2		5
Bolt head identification marks as per grade NOTE: Manufacturing Marks Will Vary				  
		Torque		Torque
Bolt Size		Foot Pounds		Foot Pounds
Inches	Millimeters	Min.	Max	Min
1/4	6.35	5	6	9
5/16	7.94	10	12	17
3/8	9.53	20	23	35
7/16	11.11	30	35	54
1/2	12.70	45	52	80
9/16	14.29	65	75	110
5/8	15.88	95	105	150
3/4	19.05	150	185	270
7/8	22.23	160	200	400
1	25.40	250	300	580
1 1/8	25.58			800
1 1/4	31.75			1120
1 3/8	34.93			1460
1 1/2	38.10			1940
				2200
				696
				880
				1240
				1680
				324
				480
				64
				96
				132
				180
				205
				29
				54
				84
				132
				192
				264
				456
				720
				1080
				1440
				2000
				2720
				3560

* Thick nuts must be used with Grade 8 bolts

HYDRAULIC LEVEE PLOW

MODELS "LF6" and "LJ6"

9" or 10-1/2" Spacing

STANDARD SPECIFICATIONS

(Metrics in Parentheses)

AXLES:	1-1/2" sq, high carbon cold rolled steel	GANG ANGLE:	15° to 28°
BLADES:	24" x 1/4"(6mm) Plain with 10" backup blade behind outside blades,	TILT INDICATOR:	One to mount with 3/4" x 2" Hyd. Cylinder for adjustment on the gc.
SCRAPERS:	High carbon replaceable and adjustable blades with 3/8" x 2" heat treated spring steel shanks, mounted to 3" x 2" x 3/8" high carbon angle iron bar with flange lock nuts and 5/8" carriage bolts.	MAIN FRAME:	7" x 4" x 3/8" Tool bar with 4SAE Cat. II and Cat. III hitch for quick coupler and conventional three point
GANG TILT:	Hydraulically controlled-on-the-gc adjustment	BEARINGS:	Four Protect-O-Shield®, extra heavy duty 1-1/2"(38mm) square bore greasable ball type, toggle mounted, with zerkl guards and wear guards.
HYD. CYLINDERS:	One 3 x 8" and one 3-1/4 x 8" rephasing cylinders to control tilt	SPACING:	9" on LF6, 10-1/2" on LJ6
HYDRAULIC HOSES:	3/8" dia. Hoses to mount from hydraulic cylinders to tractor.	SPACER SPOOLS:	Fabricated steel
		TRANSPORT WIDTH:	9'
		WRENCH:	One for gang bolts

Model No.	Adjustable Cutting Width	No. of Discs	Blade Spacing	Approximate Drawbar HP Required	Approximate Weight lbs (kg)
LF6-824	8'11" to 9'11"	8	9"	80-125	2060 (934)
LF6-1024	10'5" to 11'5"	10	9"	90-150	2260 (1025)
LJ6-824	9'5" to 10'5"	8	10-1/2"	85-140	2150 (980)
LJ6-1024	11'1" to 12'1"	10	10-1/2"	100-160	2360 (1070)
OPTIONAL EQUIPMENT					
AD-01-0007	Feathering blade (set of 2) with scraper and back-up blade (Note: Feathering blade requires two drilled and tapped bumper washers #9579A)			Add	74.0 (34.0)
	24"x1/4"(6mm) cutout blades in lieu of standard			Ded ea.	1.3 (0.6)
	26"x1/4"(6mm) plain blades in lieu of standard			Add ea.	5.8 (2.6)
	26"x1/4"(6mm) cutout blades in lieu of standard			Add ea.	3.8 (1.7)

OTHER STANDARD FEATURES

Two parking stands.
Adjustable cutting width.
Follow the levee feature-gangs can shift independent from the tractor to follow true on sharply curving levees.

Gangs easily reverse to tear down levees.
Ductile iron bearing risers
Our Levee Plows feature our exclusive Protect-O-Shield® bearing with a TWO year warranty.

AMCO PL Effective August 15, 2011

F.O.B. Yazoo City Mississippi

SPECIFICATIONS AND PRICES SUBJECT TO CHANGE WITHOUT NOTICE

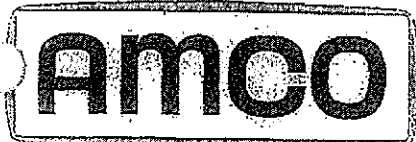

AMCO Manufacturing Company
P. O. Box 1197, 800 South Industrial Parkway, Yazoo City, MS 39184 USA
(800)748-9022 (662)746-4464 Fax (662)746-6825
www.amcomfg.com

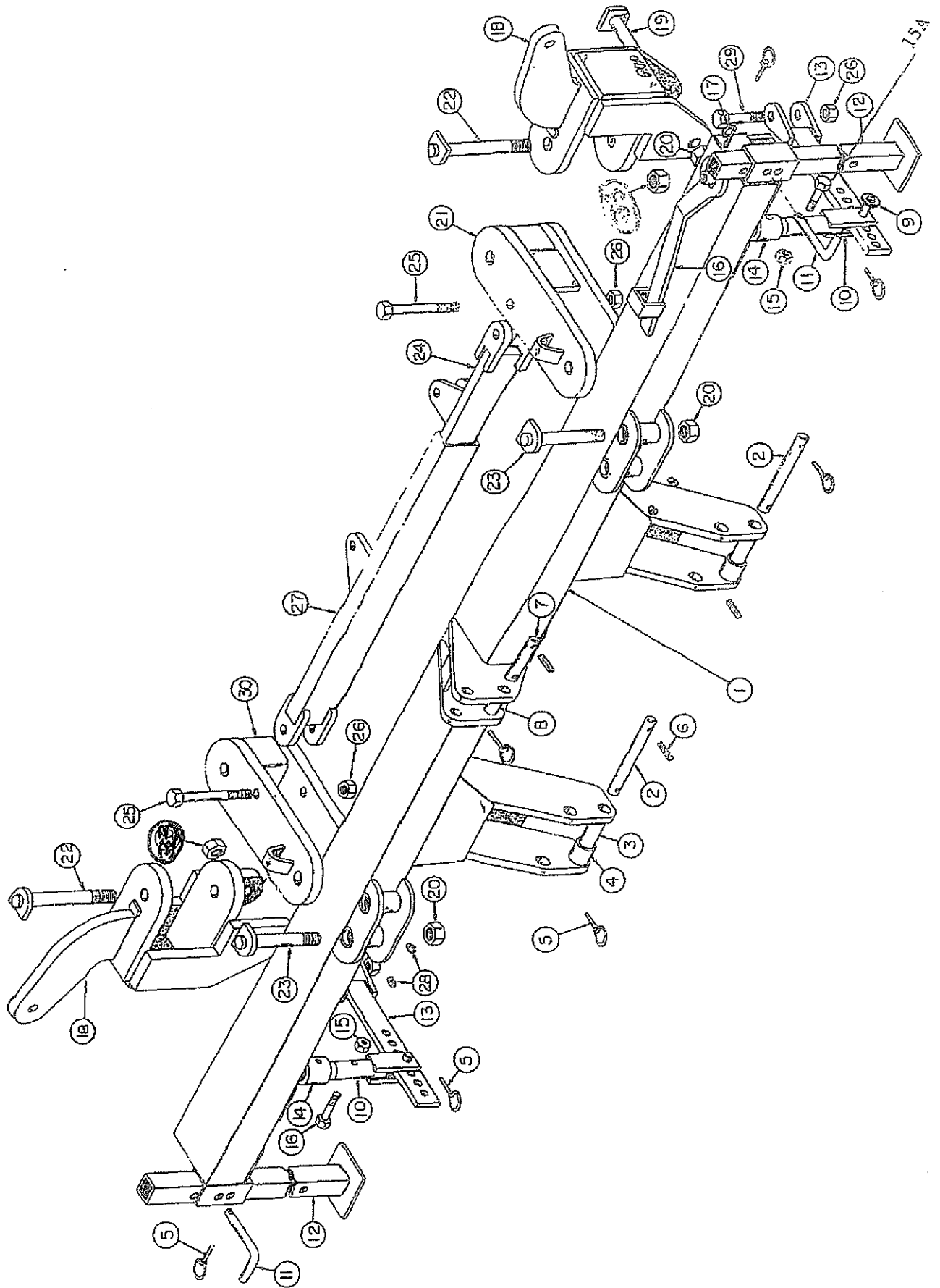

**AMCO LEVEE PLOW
LF6-LJ6 SERIES
MAIN FRAME**

<u>Ref. No.</u>	<u>Part No.</u>	<u>Description</u>	<u>No. Req'd.</u>
1	20154	Assy. Main Frame	1
2	100758	Lower Hitch Pin 1-1/8" Dia., 9-3/4" Long	2
3	100640	Bushing 1-7/16" O.D. x .155 W.T. --2 3/4" Long	4
4	100673	Spacer 2" O.D. x 1/4" W.T. --2" Long	2
5	10317	Klik Pin	7
6	10910	Roll Pin	3
7	101333	Upper Hitch Pin 1" Dia., 5-1/4" Long	1
8	6570	Bushing 1-1/4" O.D. x .109 W.T. -- 2" Long	1
9	0388	Transport Pin Assy	2
10	20165	Link Anchor Assy	2
11	100683	Lock Pin - 3/4" Dia.	2
12	20166	Parking Stand Assy	2
13	20164	Adjusting Link Assy	2
14	101332	Bushing 2-1/2" O.D. x 11/32 W.T. -- 2-1/2" Long	2
15	10509	Lock Nut 3/8" NC, PL	2
15A	10871	Hex Head Machine Bolt 3/8 x 3 NC, PL, GR5	2
16	100134	Wrench	1
17	10803	Hair Pin	1
18	20625	Angle Bracket Assy	2
19	20136	Pin Assy. 1-1/4" x 10-1/8"	2
20	10397	Lock Nut 1-1/4" NC, PL	4
21	20623	Pivot Bracket Assy. - LH	1
22	20626	Pin Assy. 1-1/2" x 11-1/8"	2
23	0942A	Pin Assy. 1-1/4" x 8-7/8"	2
24	20160	Inner Slide Link Assy	1
25	10693	Hex Head Machine Bolt 1" x 9" NC, PL	2
26	10868	Lock Nut 1" NC, PL	4
27	20161	Outer Slide Link Assy.	1
28	11081	Grease Fitting 1/8" NPT	4
29	10228	Hex Head Machine Bolt 1 x 4-1/2 NC, PLT, GR5	2
30	20624	Pivot Bracket Assy. - RH	1
31	11494	Ratchet Jack (Not Shown)	1
32	11396	Pin Assy. (Not Shown)	2
33	12452	Nylon 1-1/2" NC Insert Jam Nut	2

NOTE: This list of parts is to be used after Serial Number 01070265

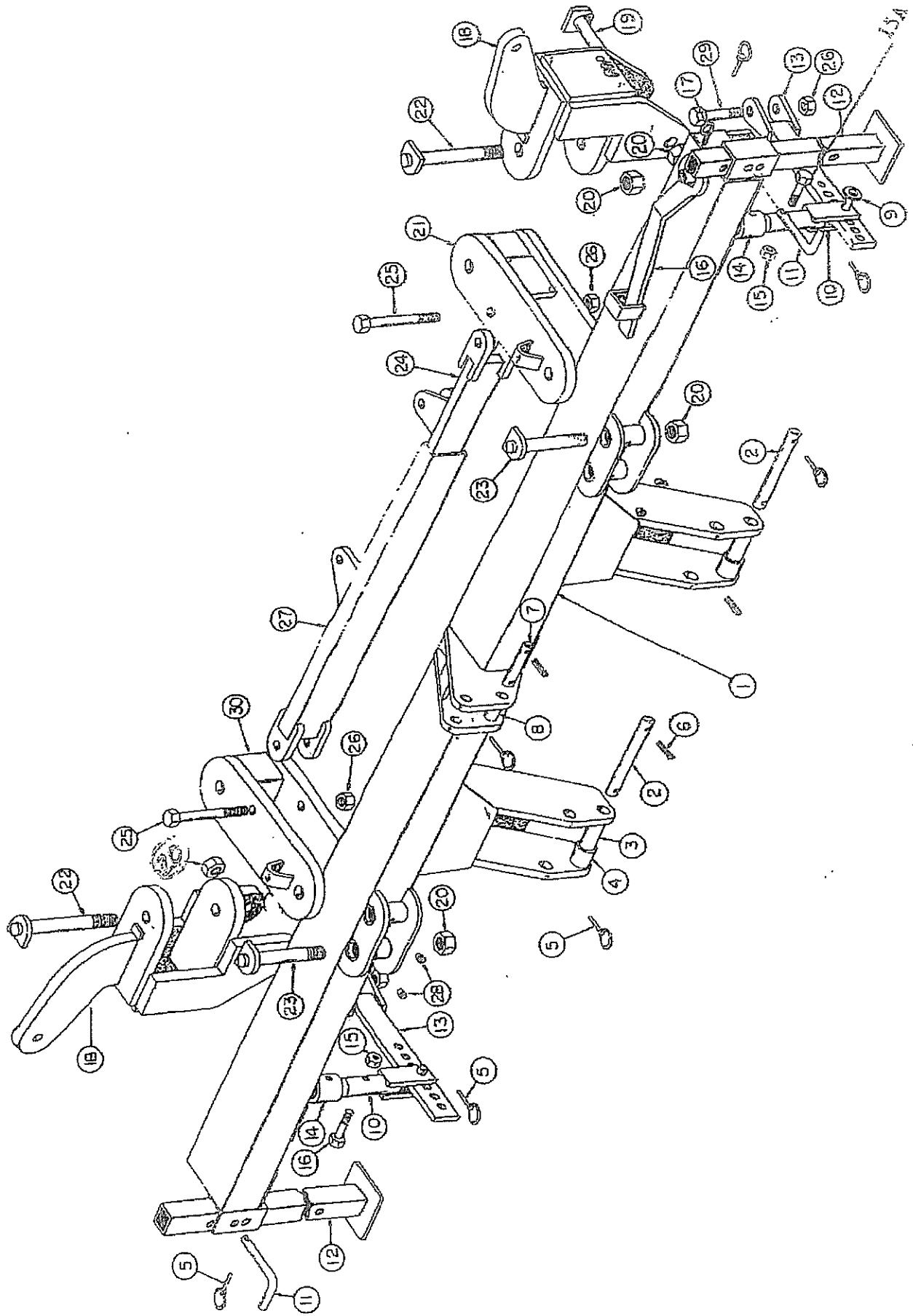

**AMCO LEVEE PLOW
LF6-LJ6 SERIES
MAIN FRAME**

<u>Ref. No.</u>	<u>Part No.</u>	<u>Description</u>	<u>No. Req'd.</u>
1	20154	Assy. Main Frame	1
2	100758	Lower Hitch Pin - 1-1/8" Dia., 9-3/4" Long	2
3	100640	Bushing 1-7/16" O.D. x .156 W.T. --2-3/4" Long	4
4	100673	Spacer 2" O.D. x 1/4" W.T. - 2" Long	2
5	10317	Klik Pin	7
6	10910	Roll Pin	3
7	101333	Upper Hitch Pin 1" Dia. - 5-1/4" Long	1
8	6570	Bushing 1-1/4" O.D. x .109 W.T. - 2" Long	1
9	0388	Transport Pin Assy.	2
10	20165	Link Anchor Assy.	2
11	100683	Lock Pin - 3-4" Dia.	2
12	20166	Parking Stand Assy.	2
13	20164	Adjusting Link Assy.	2
14	101332	Bushing 2-1/2" O.D. x 11/32" W.T. - 2-1/2 Long	2
15	10509	Lock Nut 3/8" NC, PL	2
15A	10871	Hex Head Machine Bolt 3/8" x 3" NC, PL, Gr.5	2
16	100134	Wrench	1
17	10803	Hair Pin	1
18	20157	Angle Bracket Assy.	2
19	20136	Pin Assy. 1-1/4" x 10-1/8"	2
20	10397	Lock Nut 1-1/4" NC, PL	6
21	20158	Pivot Bracket Assy. - LH	1
22	20167	Pin Assy. 1-1/4" x 11-1/8"	2
23	0942A	Pin Assy. 1-1/4" x 8-7/8"	2
24	20160	Inner Slide Link Assy.	1
25	10693	Hex Head Machine Bolt 1" x 8" NC, PL	2
26	10868	Lock Nut 1" NC, PL	4
27	20161	Outer Slide Link Assy.	1
28	10606	Grease Fitting 1/8" NPT	4
29	10228	Hex Head Machine Bolt 1" x 4-1/2" NC, PLT, Gr.5	2
30	20159	Pivot Bracket Assy. - RH	1
31	11494	Ratchet Jack (Not shown)	1
32	11396	Pin Assy. (Not shown)	2

NOTE: This list of parts is to be used before Serial Number 01070265.

**AMCO
MODELS
LF6 & LJ6**

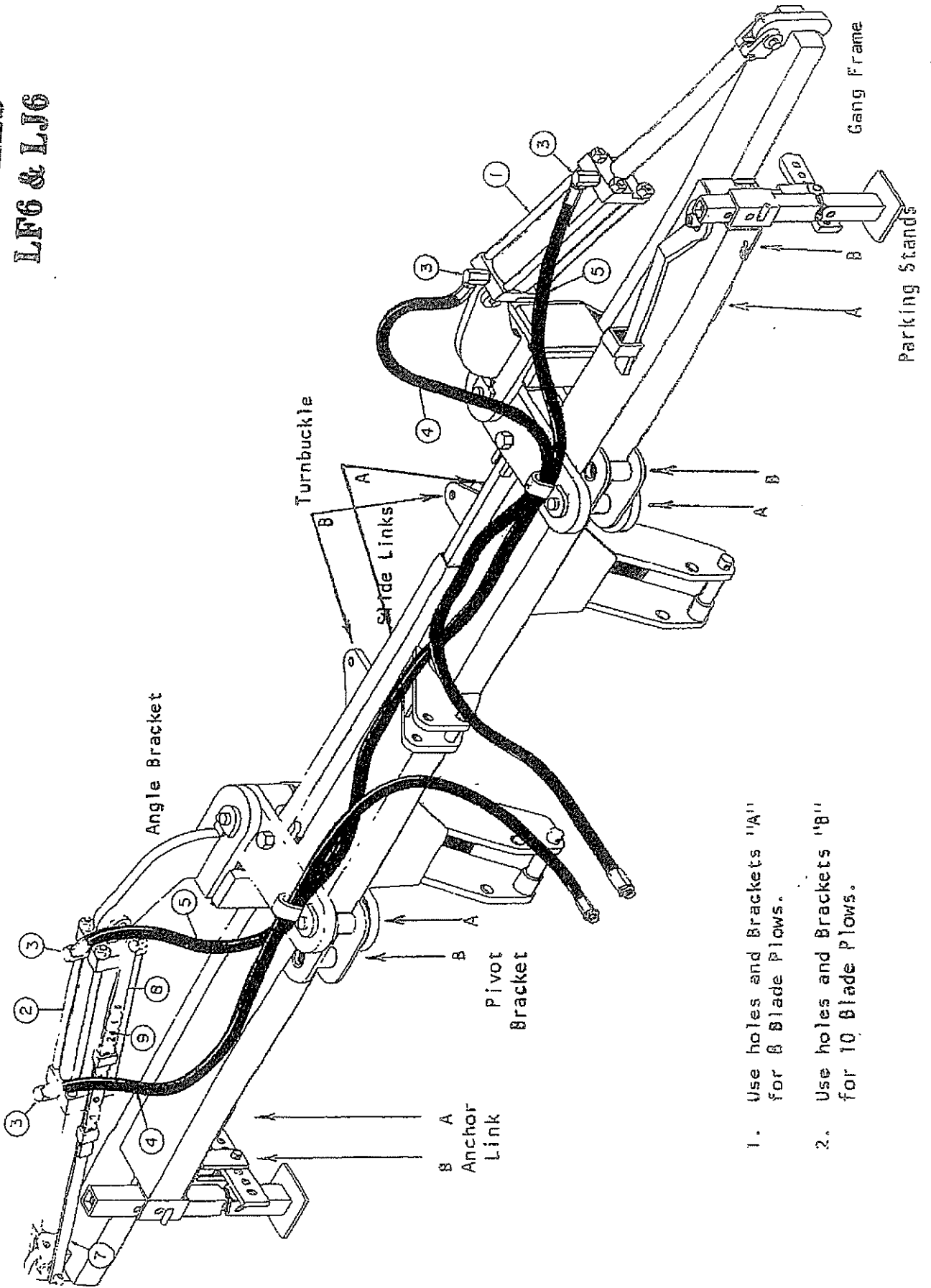

1. Use holes and Brackets "A" for 8 Blade Plows.
2. Use holes and Brackets "B" for 10 Blade Plows.

**AMCO LEVEE PLOW
HYDRAULIC CIRCUIT**

Ref. No	Part No.	Description	No. Req'd.
1	12084A	3-1/4 x 8 Hydraulic Cylinder (Lion 3000 PSI)	1
2	12083A	3 x 8 Hydraulic Cylinder (Lion 3000 PSI)	1
3	12180	1/2 Male to 1/2 Femal Swivel Elbow	4
4	11307	Hydraulic Hose 3/8 I.D. -- 120" Long	2
5	11309	Hydraulic Hose 3/8 I.D. -- 144" Long	1
6	10856	Roll Pin 5/16 x 1-1/2" (Not Shown)	8
7	20168	Assy. Indicator (Female)	1
8	101356	Indicator (Male)	1
9	11662	Decal - Tilt Indicator	1
10	101440	Special Pins not shown connecting tilt indicators and 3 x 8 Hydraulic Cylinder	2

NOTE: Insert male and femal indicators. Attach decal to male idicator with "O" number the 1-1/32" diameter hole.

IMPORTANT: 3 x 8 Hydraulic Cylinder must be mounted on right hand side of unit. This is determined by standing to the rear of the unit, and the 3-1/4 x 8 Hydraulic Cylinder on the left.

3 x 8 LION HYDRAULIC CYLINDER

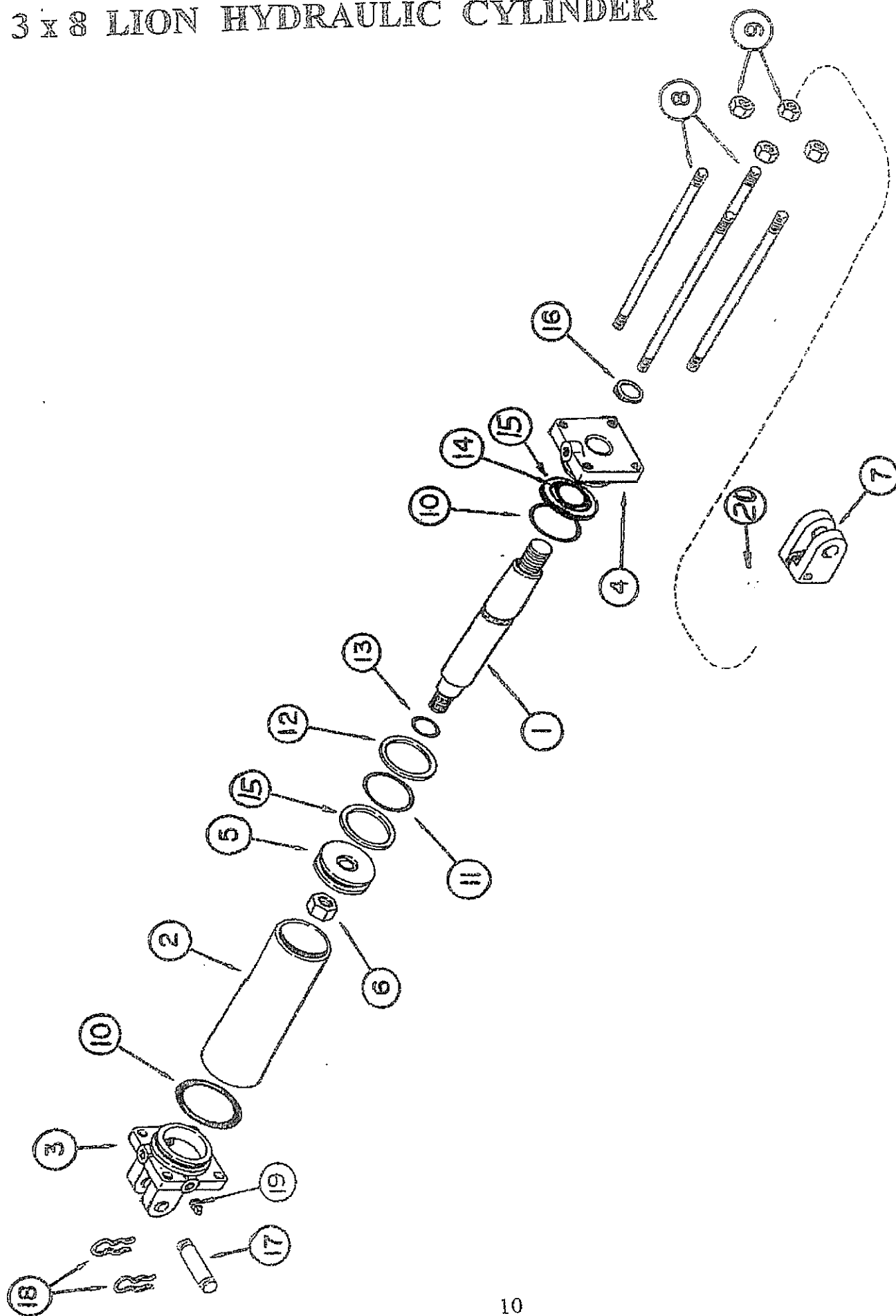

HYDRAULIC CYLINDER AMCO LEVEE PLOW 3 X 8 LION HYDRAULIC CYLINDER 3000 PSI			
<u>Ref. No.</u>	<u>Part No.</u>	<u>Description</u>	<u>No. Req'd.</u>
	12083A	3 x 8 Hydraulic Cylinder Complete	
1	12279	Piston Rod	1
2	12280	Barrel	1
3	12281	Butt	1
4	12282	Piston Head	1
5	12283	Piston	1
6	12284	Lock Nut 1" - 14 NC Gr. B	1
7	12285	Rod Clevis	1
8	12286	Tie Rod	4
9	12287	Hex Nut 5/8" NF. Gr. 5	8
20	12288	Rod Clevis Set Screw Socket 3/8 NCX 1/2 KNUR	1
21	12238	Seal Repair Kit	1
10		Rod Seal	1
11		O-Ring	1
12		Piston Seal	1
13		Rod Static Seal	1
14		Back-Up Ring	1
15		Gland Static Seal	2
16		Wiper	1
NOTE: Seal Repair Kit parts available in Repair Kits only. (Ref. No. 10-16)			
NOTE: Beginning with Serial No. 97020056 order above parts.			

3-1/4 x 8 LION HYDRAULIC CYLINDER

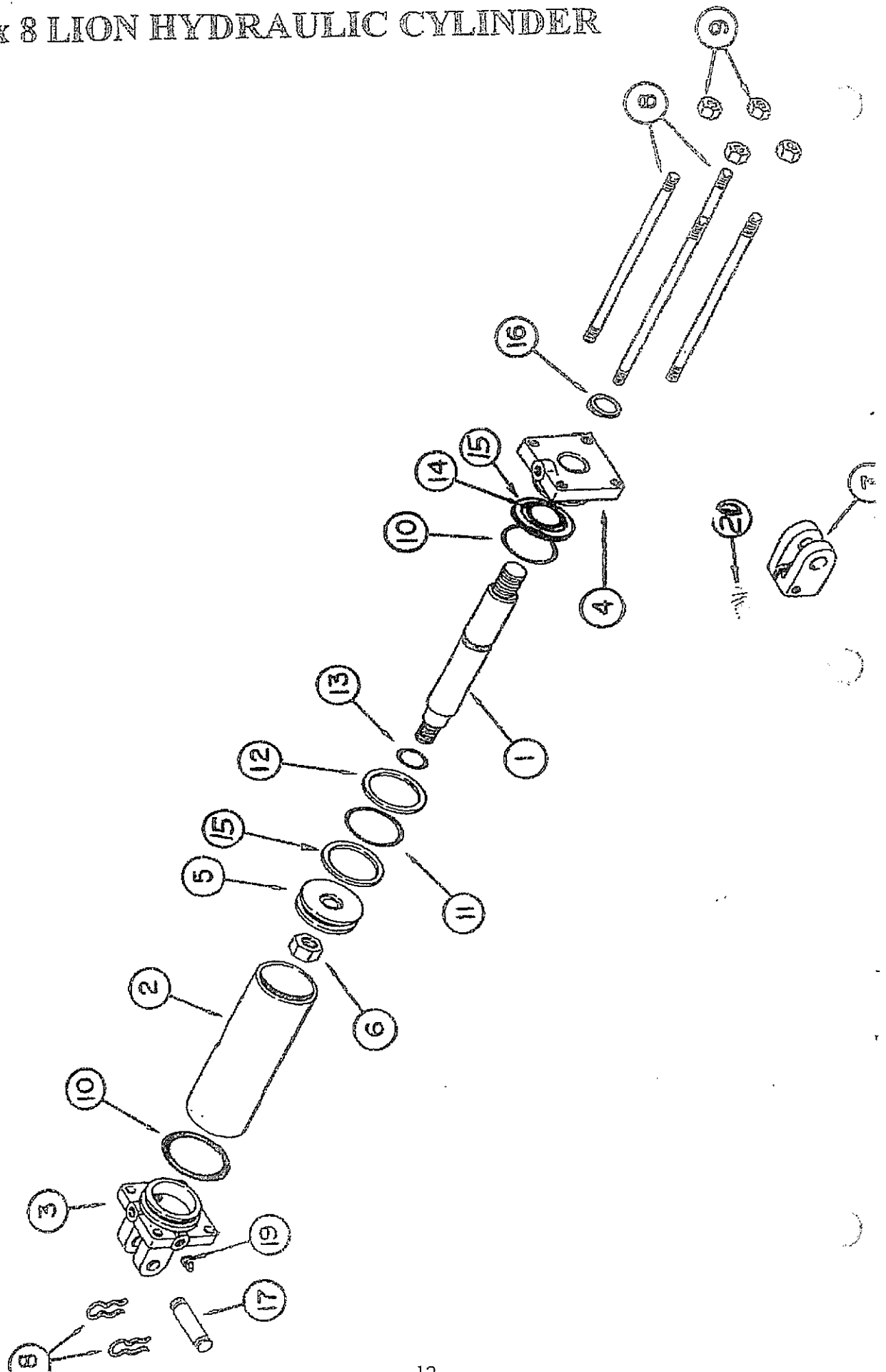

HYDRAULIC CYLINDER			
AMCO LEVEE PLOW			
3 1/4 X 8 LION HYDRAULIC CYLINDER			
3000 PSI			
Ref. No.	Part No.	Description	No. Req'd.
	12084A	3-1/4 x 8 Hydraulic Cylinder Complete	
1	12289	Piston Rod	1
2	12290	Barrel	1
3	12291	Butt	1
4	12292	Piston Head	1
5	12293	Piston	1
6	12284	Lock Nut 1" - 14 NF Gr. B	1
7	12285	Rod Clevis	1
8	12294	Tie Rod	4
9	12295	Hex Nut 5/8" NF, Gr. 5	8
20	12288	Rod Clevis Set Screw Socket 3/8 UNCX 1/2 KNUR	1
21	12239	Seal Repair Kit	1
10		Rod Seal	1
11		O-Ring	1
12		Piston Seal	1
13		Rod Static Seal	1
14		Back-up Ring	1
15		Gland Static Seal	2
16		Wiper	1
17		Pin Assy.	2
NOTE: Seal Repair Kit parts available in Repair Kits only. (Ref. No. 10-16)			
NOTE: Beginning with Serial No. 97020056 order above parts.			

GANGS & FRAMES

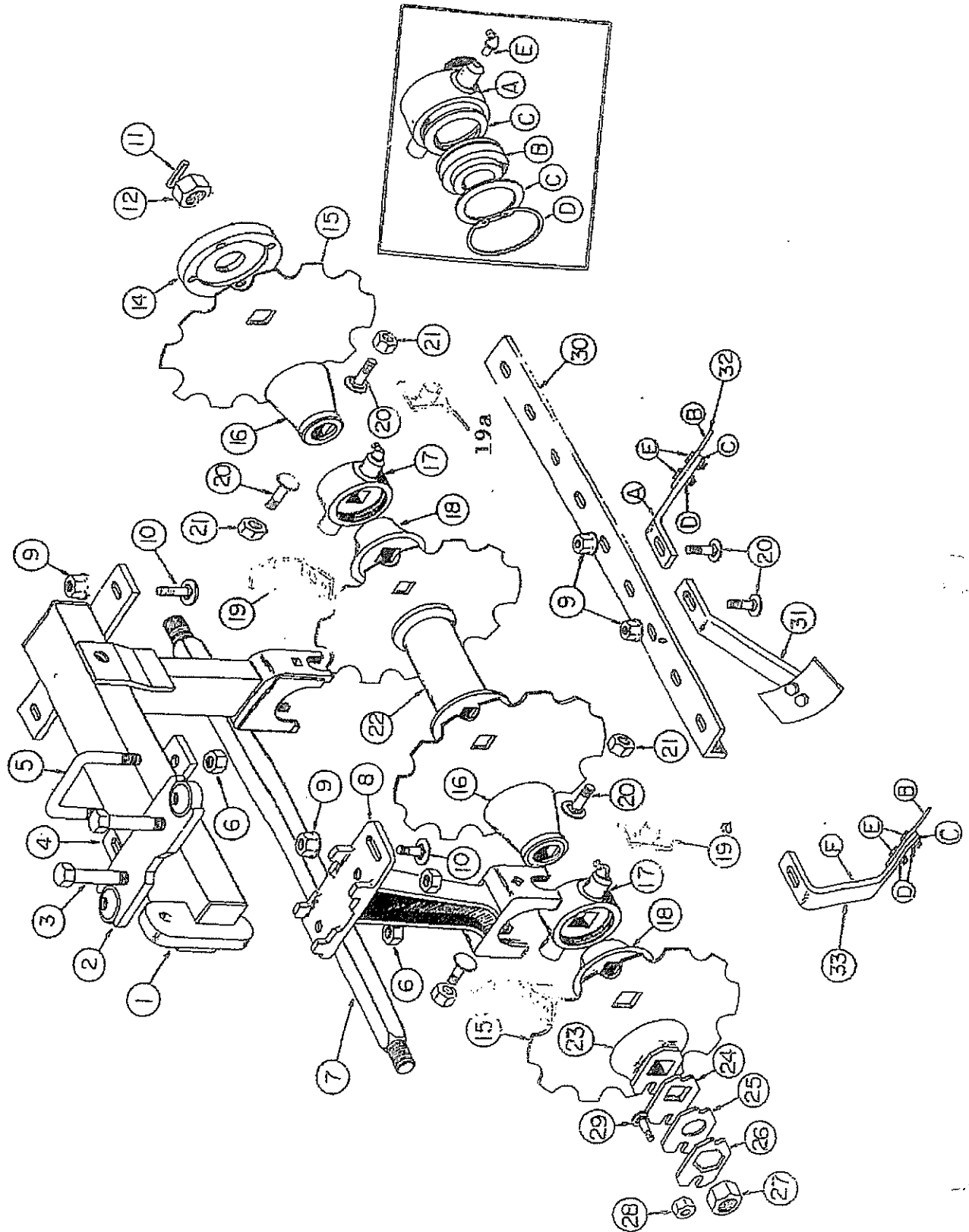

AMCO LEVEE PLOW				
LF6 - LJ6 (8-BLADE)				
GANGS & FRAMES				
Ref. No.	Part No.	Description	No.	Req'd.
			LF6	LJ6
1	20155	Assy. Gang Frame - 3' x 5" - 31-1/2" Long	1	1
2	20162	Assy. Link Mount	1	1
3	10591	Hex Head Machine Bolt 7/8" x 6" NC, PL, Gr.5	2	2
4	101336	Scraper Bar Support	1	1
5	11280	U-Bolt 7/8" Dia	1	1
6	10396	Lock Nut 7/8" NC, PL	6	6
7	9440	Gang Bolt 1-1/2" Sq. - 33-5/8" -- 4-Blade	1	0
7	9449	Gang Bolt 1-1/2" Sq. - 38-3/4" --4 Blade	0	1
8	16012A	Bearing Riser (PP)	1	1
9	11647	Flange Lock Nut 5/8" NC, PL	6	6
10	10722	Carriage Bolt 5/8" x 2-1/2" NC, PL, Gr. 5	2	2
11	11659	Steel Roll Pin (Grooved) 5/16" x 2-1/2"	1	1
12	9577A	Gang Bolt Nut PP Cast Steel	1	1
14	9578A	Bumper Washer	1	1
15	3255	Blade 24" x 1/4" Plain	4	4
15	3250	Blade 24" x 1/4" Cut-Out	4	4
15	3263	Blade 26" X 1/4" Plain	4	4
15	2456	Blade 26" x 1/4" Cut-Out	4	4
15A	3278	Blade 10" x 11" Ga. Plain Back-up (Not Shown)	1	1
16	17007	End Bell - Small	2	2
17	FB-09-0015	Bearing & Housing Assy.	2	2
A	16003	Bearing Housing	1	1
B	11503	Bearing 100mm GW211PP17	1	1
C	11064	Snap Ring	1	1
D	100104	Washer 100mm	2	2
E	12384	Grease Fitting 1/8" NPT Straight	1	1
18	17008	End Bell - Large	2	0
18	17006	End Bell - Large	0	2
19A	20579	Grease Fitting Guard	2	2
19	102489	Wear Guard	2	2
20	10135	Carriage Bolt 5/8" x 1-3/4" NC, PL, Gr. 5	7	7
21	10299	Lock Nut 5/8" NC, PL	4	4
22	0522	Spacer Spool	1	0
22	0523	Spacer Spool	0	1
23	1222A	End Gang Washer	1	1
24	100099	Spacer Plate	1	1
25	100098	Bearing Plate	1	1
26	5622A	Lock Plate	1	1
27	10489	Gang Bolt 1-1/2" NF	1	1
28	10395	Lock Nut 1/2 NC, PL	1	1
29	10710	Carriage Bolt 1/2" x 2" NC, PL	1	1
30	101071	Scraper Bar 3" x 2" x 3/8" angle - 36-5/8"	1	0
30	101335	Scraper Bar 3" x 2" x 3/8" angle - 42-15/16"	0	1
31	20069	Assy. Scraper - LH	3	3
32	20068	Assy. Scraper - RH	3	3
A	101049	Scraper Shank	1	1
B	101019	Scraper Blade	1	1
C	10832	Cut Washer 1/2" PL	2	2
D	10395	Lock Nut 1/2" NC, PL	2	2
E	11652	Machine Bolt 1/2" x 1-1/4" NC (PLT)	2	2
F	101173	Scraper Shank	1	1
33	20112	Assy. Scraper Shank (Special) - RH	1	1
34	20113	Assy. Scraper Shank (Special) - LH	1	1

LF6 - LJ6 [10 BLADE] GANGS & FRAMES

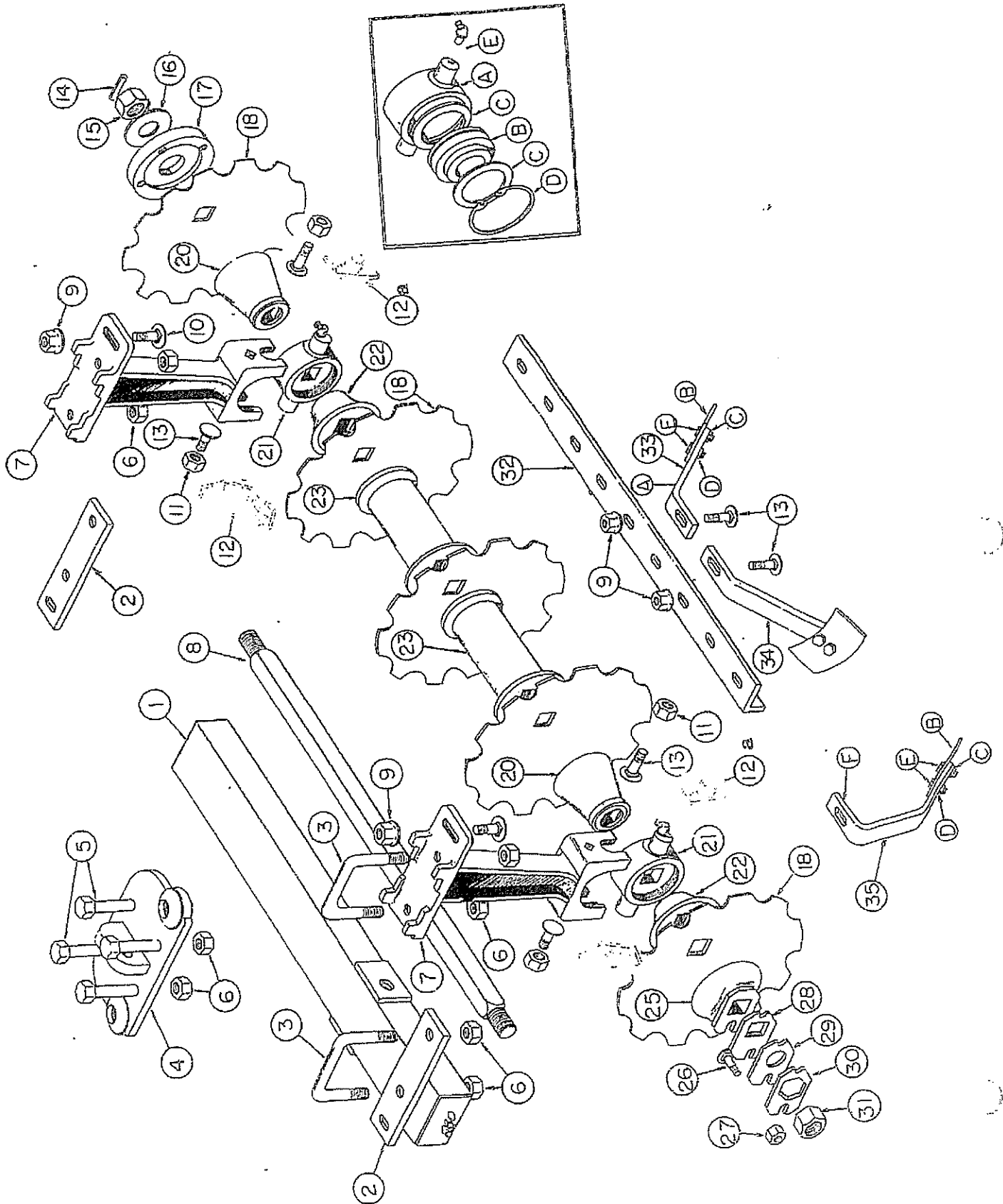

AMICO LEVEE PLOW				
LF6 - LJ6 (10-BLADE)				
GANGS & FRAMES				
Ref. No.	Part No.	Description	No.	
			LF6	LJ6
1	20156	Assy. Gang Frame - 3" x 5" x 42"	1	1
2	101336	Scraper Bar Support	2	2
3	11280	U-Bolt 7/8" Dia.	2	2
4	20163	Assy. Rear Mount	1	1
5	10591	Hex Head Machine Bolt 7/8" x 6" NC, PL, Gr.5	4	4
6	10396	Lock Nut 7/8" NC, PL	8	8
7	16012A	Bearing Riser (PP)	2	2
7	9441	Gang Bolt 1-1/2" Sq. - 42-7/8" -- 5-blade	1	0
8	9450	Gang Bolt 1-1/2" Sq. - 49-1/2" -- 5-blade	0	1
9	11647	Flange Lock Nut 5/8" NC, PL	7	7
10	10722	Carriage Bolt 5/8" x 2-1/2" NC, PL, Gr.5	2	2
11	10299	Lock Nut 5/8" NC, PL	4	4
12A	20579	Grease Fitting Guard	2	2
12	102489	Wear Guard	2	2
13	10135	Carriage Bolt 5/8" x 3/4" NC, PL, Gr.5	9	9
14	11659	Steel Roll Pin (Grooved) 5/16" x 2-1/2"	1	1
15	9577A	Gang Bolt Nut PP Cast Steel	1	1
17	9578A	Bumper Washer	1	1
18	3255	Blade 24" x 1/4" Plain	5	5
18	3250	Blade 24" x 1/4" Cut-out	5	5
18	3263	Blade 26" x 1/4" Plain	5	5
18	2456	Blade 26" x 1/4" Cut-Out	5	5
19	3278	Blade 10" x 11" Ga. Plain Back-up	1	1
20	17007	End Bell - Small	2	2
21	FB-09-0015	Bearing & Housing Assy.	2	2
A	16003	Bearing Housing	1	1
B	11503	Bearing 100mm GW211PP17	1	1
C	11064	Snap Ring	1	1
D	100104	Washer 100mm	2	2
E	12384	Grease Fitting 1/8" NPT Straight	1	1
22	17008	End Bell - Large	2	0
22	17006	End Bell - Large	0	2
23	0522	Spacer Spool	2	0
23	0523	Spacer Spool	0	2
25	1222A	End Gang Washer	1	1
26	17010	Carriage Bolt 1/2" x 2" NC, PL	1	1
27	10395	Lock Nut 1/2" NC, PL	1	1
28	100099	Spacer Plate	1	1
29	100098	Bearing Plate	1	1
30	5622A	Lock Plate	1	1
31	10489	Nut Gang Bolt 1-1/2" NF	1	1
32	101073	Scraper Bar 3" x 2" x 3/8" angle - 45-7/8"	1	0
32	101334	Scraper Bar 3" x 2" x 3/8" angle - 53-5/8"	0	1
33	20068	Assy. Scraper - RH	4	4
34	20069	Assy. Scraper - LH	4	4
A	101049	Scraper Shank	1	1
B	101019	Scraper Blade	1	1
C	10832	Cut Washer 1/2" PL	2	2
D	10395	Lock Nut 1/2" NC, PL	2	2
E	11652	Machine Bolt 1/2" x 1-1/4" NC, PL	2	2
F	101173	Scraper Shank	1	1
35	20112	Assy. Scraper (Special) - RH	1	1
36	20113	Assy. Scraper (Special) - LH	1	1

FEATHERING BLADES
[OPTIONAL]

<u>Ref. No.</u>	<u>Part No.</u>	<u>Description</u>	<u>No. Req'd.</u>
1	7673	Spacer - Plate	1
2	3262	Blade - 20" Plain 7 Ga.	1
3	7801	Cap - Blade	1
4	10189	Bolt - Machine 7/8 x 3 NC, PL, Gr. 5	1
6	10396	Lock Nut 7/8 NC, PL	1
7	10928	Cap Screw 1/2 x 1-34 NC, PL, Gr. 5	4
8	11647	Flange Lock Nut 5/8 NC, PL	1
9	20068	Assy. Scraper - RH	1
9A	20069	Assy. Scraper - LH	1
10	10135	Carriage Bolt 5/8 x 1-3/4 NC, PL Gr.5	1
11	10786	Lock Washer 1/2 PL	4
12	3278	Blade 10 x 11 Ga. Plain (Back-up)	1

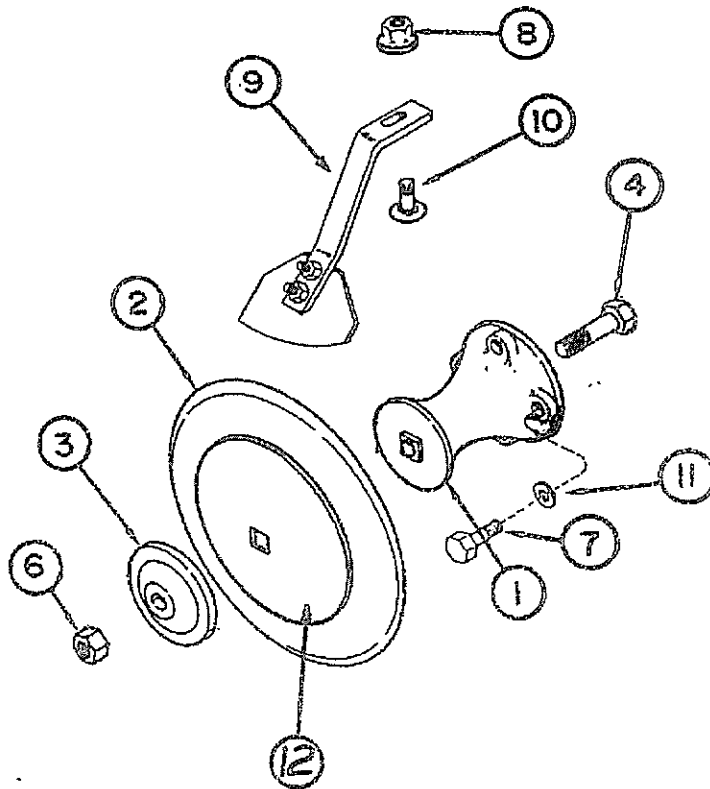

DECALS



! WARNING

- BEFORE OPERATING - STUDY OPERATORS MANUAL SAFETY MESSAGES AND SAFE OPERATING PROCEDURES, READ SAFETY SIGNS ON THIS MACHINE.
- TRANSPORT ON PUBLIC ROADS - OBSERVE FEDERAL, STATE AND LOCAL REGULATIONS; DISPLAY SMV EMBLEM; ATTACH PROPER STRENGTH SAFETY CHAIN TO TOWED IMPLEMENT; AND LIMIT MAXIMUM SPEED TO 20mph (32 km/h).
- LOWER OR BLOCK ALL ELEVATED COMPONENTS BEFORE SERVICING OR LEAVING THIS MACHINE.

11741 321-6625

MAINTENANCE INSTRUCTIONS

- Keep all bolts tight. Check after first 50 hours or one week's operation. Visually inspect all bolts daily.
- Keep wheel bearings properly adjusted. Clean and repack each season or every 300 hours. Replace all worn or damaged parts when repairing.
- Keep gang bolts tight! Tighten after first day's operation. Do not run with loose disk blades. If gang bolts have been operated in a loose condition, retighten, then tighten again after 30 minutes use, again after 4 to 5 hours, and again after 8 to 10 hours.
- Grease gang bearings daily with a hand grease gun and a good grade of clean, number 2, lithium soap base grease. Always wipe fittings clean before greasing. Apply grease until old or dirty grease is purged from bearings. Avoid high-pressure greasing.
- Inspect for damaged or misaligned parts if gangs do not turn smoothly by hand. Bearings will fail prematurely if operated with misaligned or damaged gang parts. If a gang is operated for one or more hours following a bearing fail, replace all bearings on the gang.

Refer to the operator's manual for other important maintenance instructions.

AMCO LEVEE PLOW LF6 - LJ6 SERIES			
Ref. No.	Part No.	Description	No. Req'd.
1	11465	Decal - AMCO (2 on front - 2 on rear)	4
2	12451	Reflector - Red (mount on rear)	2
3	12450	Reflector - Amber (mount on front)	2
4	11548	Decal - FEMA	1
5	11716	Decal - Maintenance Instructions	1
6	11741	Decal - Warning	1



~~THIS SAFETY ALERT SYMBOL INDICATES IMPORTANT SAFETY~~
~~MESSAGES IN THIS MANUAL. WHEN YOU SEE THIS SYMBOL,~~
~~CAREFULLY READ THE MESSAGE THAT FOLLOWS AND BE ALERT TO~~
~~THE POSSIBILITY OF PERSONAL INJURY.~~



CAUTION Never stand between tractor and levee plow when hitching unless all controls are in neutral and the brakes are locked.



CAUTION Park or block the levee plow so it will not roll when disconnected from the tractor.



CAUTION When working on the plow, care should be exercised in handling or tightening bolts near disk blades to avoid injury.



CAUTION When transporting machinery over public roads, comply with your local and state laws regarding length, width and lighting.



CAUTION When trailing the harrow over public roads, the SMV Emblem must be used, for protection of tractor and motor vehicle operators.



CAUTION When transporting farm implements on public roads after dusk it is the responsibility of the operator to provide lighting and reflectors on the rear of the implement in accordance with your state law.



CAUTION All hydraulically or mechanically elevated operating components must be blocked to prevent accidental lowering or must be lowered to the ground when making adjustments or when the equipment is idle.

assembly instructions

Models LF6 & LJ6

The plow is shipped from the factory with maximum pre-assembly in the following bundles:

- A. Main Frame
- B. Two gang & frame bundles with scrapers & scraper bars attached
- C. Hydraulic cylinders and hoses

Place all bundles where they will be convenient. Arrange loose parts so they may be readily seen when needed. To insure good alignment of the units and parts, always insert all bolts leaving the nuts loose. Tighten the nuts evenly to prevent misalignment, distortion, or binding. Be sure all bolts are tight, all cotter pins properly spread and all pins properly inserted.

STEP 1
Select clean level area for assembly. Place parking stands in main frame. Set main frame on sturdy assembly stands 37" high.



CAUTION Use sturdy stands to prevent frame from falling.

STEP 2

Attach the pivot brackets to the two inside holes in the main frame for an eight blade gang and to the two outside holes for a ten blade gang. Use the 1 1/4" x 8 7/8" pins. Attach the angle brackets to the pivot brackets by the 1 1/4" x 11 1/8" pins.

STEP 3

Connect inner and outer slide links to angle brackets by the 1 x 8 bolts. Now, attach the ratchet jack to the inner and outer slide links. Install in the top holes for the ten blade and in the bottom holes for an eight blade.

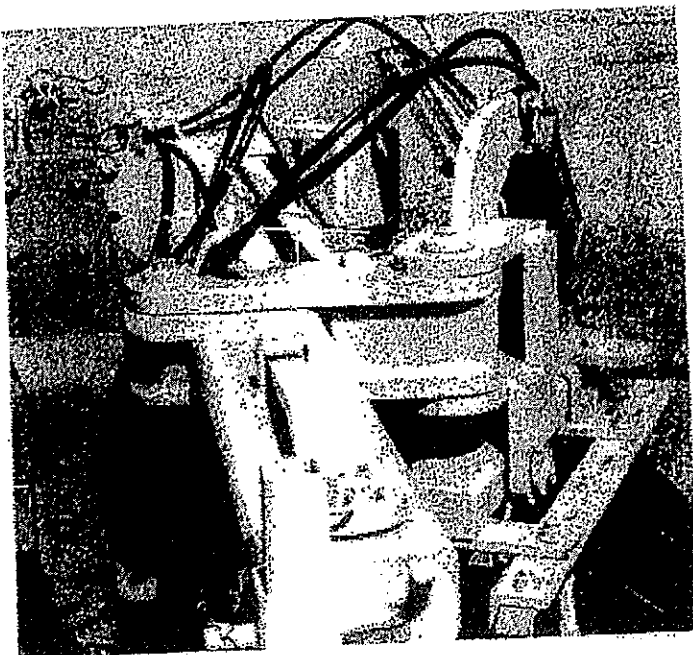
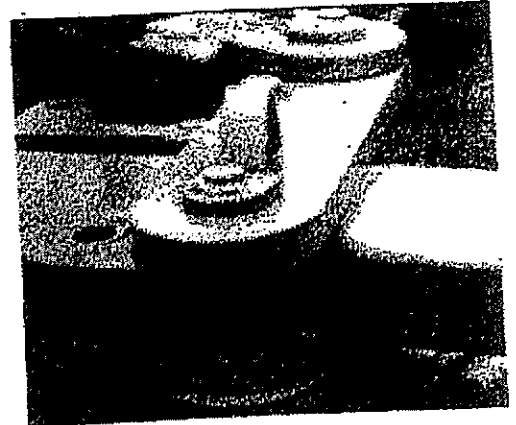

STEP 4

Attach gangs and frames to angle bracket by the 1 1/4 x 10 1/8 pin. Connect adjusting link to mount on gang frame and to the link anchor on the main frame.

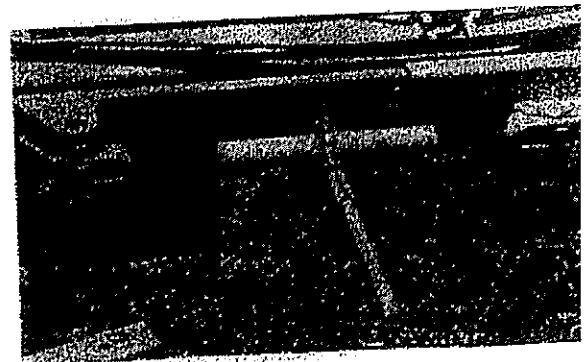

Install a 3" x 8" hydraulic cylinder on the right hand gang; connect to angle bracket. Install a 3 1/4" x 8" hydraulic cylinder on the left hand gang; connect to angle bracket. Make sure the butt end of each cylinder is connected to the angle brackets and the rod end attached to the gang frames. Install the depth indicator on the 3 x 8" cylinder and secure with roll pins.

STEP 6

Install hydraulic fittings and hoses as follows:

- (A) Install four #10921 1/2 male to 1/2 female swivel elbows into the ports on the 3 1/4 x 8 and 3 x 8 hydraulic cylinders. Turn fittings as shown in drawing. Coat fittings with pipe sealant before installation. Do Not put sealant over end of fitting. This will keep the sealant out of the tractor hydraulic system. Tighten fittings!
- (B) Connect cylinders with hoses. Lay the hoses out where they will be readily accessible. Connect hoses and fittings as follows:
- (1) The #11309 3/8 x 144 hose connects the rod end of the 3 1/4 x 8 to the butt end of the 3 x 8 cylinder. Route hoses through supports.
 - (2) The two #11307 3/8 x 120 hoses are used to connect the butt end of the 3 1/4 x 8 cylinder & the rod end of the 3 x 8 cylinder to the tractor. Route hoses through supports.

This completes assembly of the hydraulic circuit for gang tilt. Carefully check your assembly and hose routing. All hoses must be routed through the support brackets to prevent damage.

STEP 7

Final grooming and check points:

- (A) Check all bolts for proper torque.
- (B) Check scraper adjustment. Scrapers should be adjusted to run 1/16" to 1/8" from disk blades.
- (C) Check all hydraulic hoses and fittings for leaks. Repair as required. Replace fittings that continue to leak after tightening.
- (D) Lubrication for plow:
Raise plow to transport position. Use a good grade of clean Lithium soap base chassis grease to grease the entire plow. This is very important if the plow will be kept in inventory for several weeks before being placed in service. Grease the plow as follows:
- (1) Grease all pivot pins until grease appears.
 - (2) Grease the fitting on the ratchet jack.
 - (3) Grease the gang bearings with 4 or 5 shots of grease to purge any condensation that has accumulated during shipment and storage. If the harrow is in storage for four to six months, the entire plow should again be lubricated before placing in service. It should also be greased every 50 hours while in use, at the end of each season and at the start of each season.

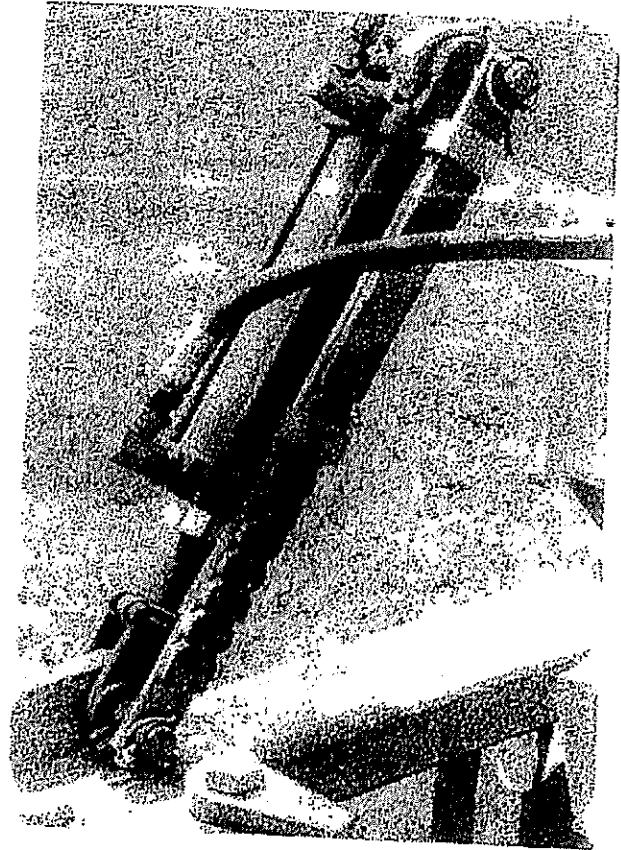

CAUTION Hydraulic systems are highly pressurized. Escaping hydraulic oil, even an invisible pinhole leak, can penetrate body tissues causing serious injury. Use a piece of wood or cardboard when looking for leaks - never use the hands or other parts of the body. Relieve hydraulic pressure before disconnecting circuits. When reassembling, make absolutely certain that all connections are tight.

If injured by hydraulic oil escaping under pressure, see a doctor immediately. Serious infection or reaction may occur if medical attention is not given at once.

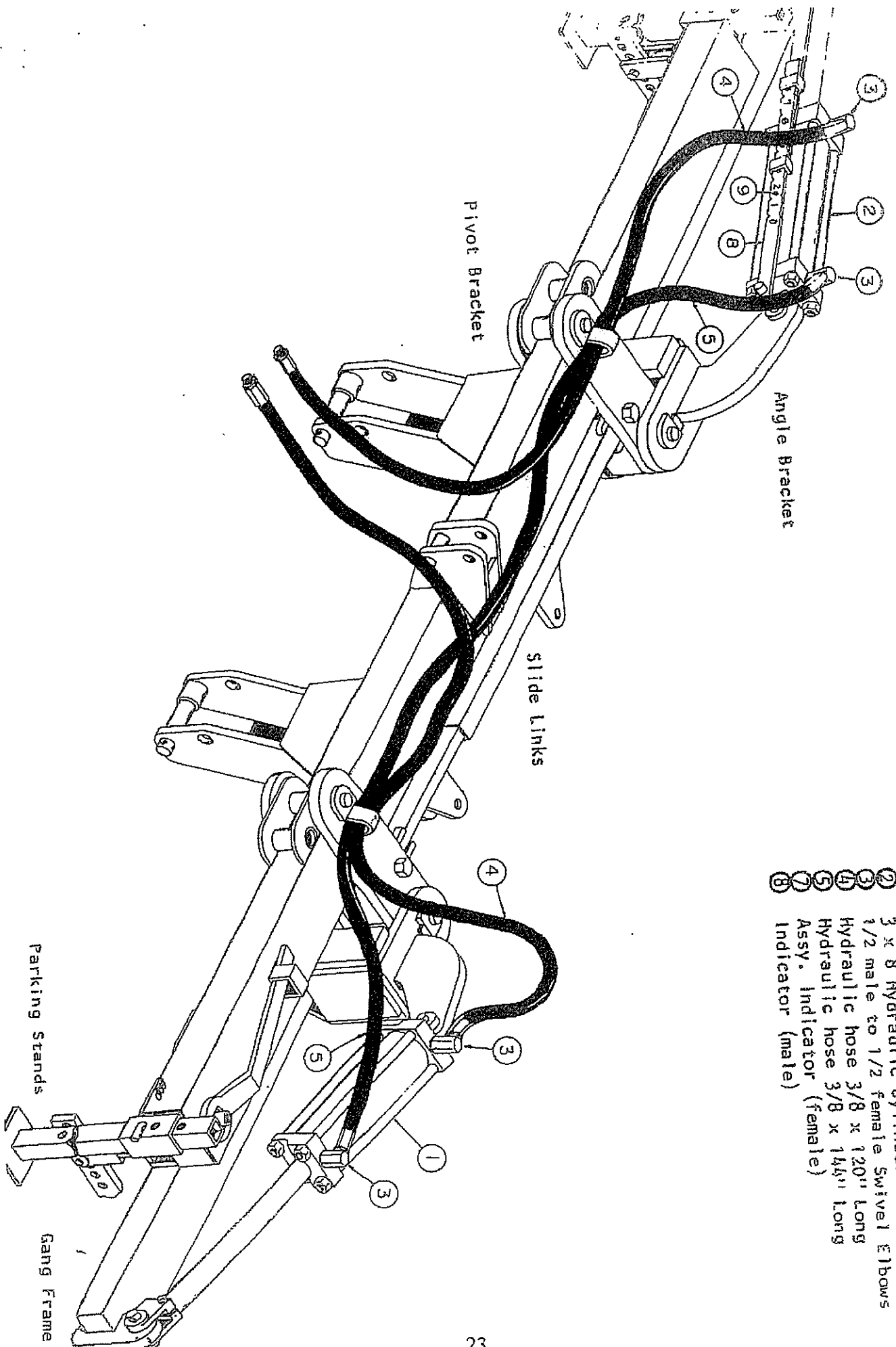

- ① 3 1/4 x 8 Hydraulic Cylinder
- ② 3 x 8 Hydraulic Cylinder
- ③ 1/2 male to 1/2 female Swivel Elbows
- ④ Hydraulic hose 3/8 x 120" Long
- ⑤ Hydraulic hose 3/8 x 144" Long
- ⑥ Assy. Indicator (female)
- ⑦ Indicator (male)
- ⑧

- (E) Check decals to be certain they are in place and in good condition. Touch-up paint as required before delivery. Place operator's manual in the heavy plastic shipping bag. Tape bag to main frame so the operator's manual will be delivered to your customer along with the plow.
- (F) Review all steps of the assembly process to be certain the plow is properly assembled. Check all bolts to be sure they are properly torqued. Visually inspect the plow for any missing, damaged, or defective parts. Repaint any areas that need improvements.

Remember, a little extra attention to details at this time can prevent problems after the plow is placed in service.

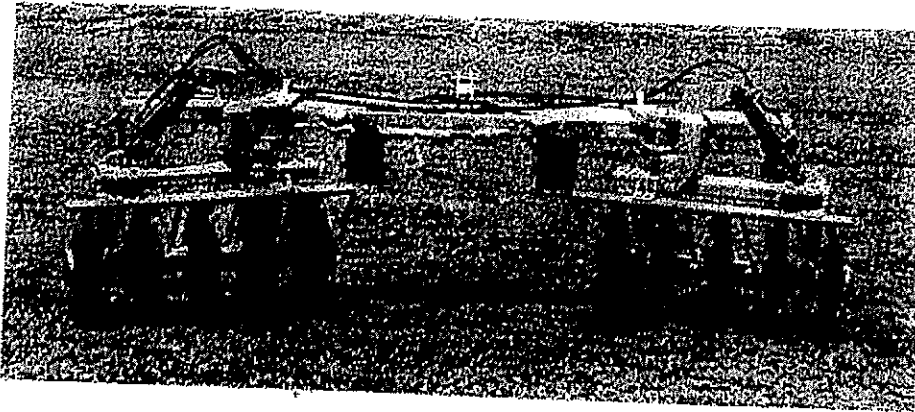

Lubrication

Careful and regular attention to lubrication will greatly increase the life of the plow. For economical and efficient operation, proper lubrication of the gang bearings, pivot bracket pins, and ratchet jack is necessary.

Be sure the grease fittings are free of dirt or paint before using the grease gun. Replace any damaged or missing fittings. Use a good grade No. 2 grease (lithium base). Never use greases which contain metallic additives. Always make sure that grease is clean and not contaminated with dirt or other foreign matter.

The gangs are equipped with ball bearings, which are initially greased at the factory. They should be greased at least every week or fifty (50) hours of operation under normal conditions. Daily greasings may be necessary under extreme conditions such as in wet ground, during hot dry weather or when operating at high speeds. These bearings must also be greased at the start of each season, and at the end of each season.

Protect-O-Shield bearings should be greased until grease "pops" out around the bearings. The bearing will thus be purged of any dirt or foreign matter. The Protect-O-Shield prevents any possibility of blown seals.

Grease pivot bracket pins each week or fifty (50) hours of operation. These pivot bracket pins should also be greased at the start of each season and at the end of each season.

Bushings should be checked each season and replaced when worn.

Grease ratchet jack each week or fifty (50) hours of operation.

storage

Proper storage will add to the life of your levee plow, and assure its being in good condition for the next season. The following procedure is recommended.

Clean off all foreign matter, and thoroughly lubricate the plow. (See lubrication instructions)

Tighten loose bolts and replace any damaged or missing parts.

Repaint the plow where the original paint has worn off.

Coat the hydraulic cylinder rods with a good rust preventative or fully retract cylinder rods.

Coat the disk blades with a good rust preventative.

Store in a dry place with the parking stands lowered and pinned to prevent the plow from falling forward. Check to make sure the plow cannot be overturned either forward or backward accidentally.

Carefully rotate each gang and check for worn or damaged blades, bent gang shafts, worn scrapers, damaged bearings and other parts which may need replacing.

Whenever disk blades or bearings are replaced, the gang shaft nuts must be torqued to 1200 foot pounds.



CAUTION: When working on disk harrows care should be exercised in handling or tightening bolts near disk blades to avoid injury. All hydraulically or mechanically elevated components must be blocked or lowered to prevent accidents when servicing the harrow.

maintenance

1. Keep all bolts tight.
 - A. Check before placing in service.
 - B. Visually inspect all bolts daily.
 - C. Check after first 50 hours or one week's operation.
 - D. Check each season.
2. Do not run with loose disk blades. Keep gang bolts tight! Tighten gang bolts to 1200 ft. lbs. of torque.
3. Grease gang bearings and pivot bracket pins every week or 50 hours, under normal conditions, at the start of each season, and at the end of each season. Grease more often under extreme conditions such as in wet grounds, during hot, dry weather or when operating at high speeds. Use a good No. 2 gun grease (Lithium Base). Rotate gangs while greasing for best results.
4. Disk Blade, Bearing, and Spool Replacement
 - A. Remove the nuts that hold the gang bearing housing trunion clamps.
 - B. Remove clamps.
 - C. Raise the plow and roll the gang away from the frame.
 - D. Remove the gang nut lock plate.
 - E. Remove the gang hex nut from the end of the shaft.
 - F. Slide off the bearing, spools, spacers, and blades.
 - G. Avoid thread damage.
 - H. Tear the entire gang down and clean off all parts. Check disk axle for straightness. Bowed, bent or worn axles must be replaced.
 - I. Check spacer spools for damage caused by running plow with loose gangs or hitting underground obstructions. Replace spool if it is damaged.
 - J. Carefully check all end bells. The large end must contact the disk blade around the entire circumference of the end bell. The small end must be smooth and perpendicular to the axle. The end bells must be replaced if they are cracked or worn on the surface adjacent to the bearing.
 - K. Check all the bearings on the gang. Running a plow for one hour or more after bearing failure will seriously damage other bearings on the gang. This damaged bearing will then fail within a few hours after the failed bearing has been replaced. Continued operation with this failed bearing will damage the new bearing thus it will fail after a few hours of use. In most cases it will be best to replace all bearings on a gang when it is torn down for repairs. An AMCO triple lip sealed, regreasable bearing should always be used for bearing replacement.
 - L. To replace the bearing, the snap ring must be removed. The old bearing and washers should be pressed out of the housing. Clean and wash out old grease and carefully check the housing. Replace the housing if it is damaged. Press the washers and new bearing straight into the housing. Always press against the outer race of the bearing. NEVER press against the seal or inner race of the bearing. Check location of the grease hole in the outer race of the bearing. This hole must align with the grease groove in the bearing housing. Rotate the bearing in the housing after it is pressed in to be sure it turns freely. Install the snap ring in the housing.

Operating Instructions

Your new AMCO levee plow has been set up, inspected, and adjusted by your dealer before delivery. However, before using your new harrow, or one that has been stored, make certain that all nuts and bolts are tight, all cotter pins spread and that the harrow has been lubricated.

This instruction manual should be carefully and thoroughly read to enable the operator to care for and operate the plow properly. The right and left hand sides of the levee plow as used in these instructions are determined by standing at the rear of the plow and facing the direction of travel.

Refer to your tractor operator's manual for complete tractor operating instructions.

HITCH: The AMCO levee plow is designed to hitch to ASAE Standard Category II and III three point hitches and to ASAE Standard Category II and III quick couplers. Simply pin to the appropriate holes using the spacers provided.

PARKING STANDS: Adjustable parking stands are provided as standard equipment. These stands should be raised and pinned for transport or field work. The stands should always be lowered and pinned to prevent the plow from falling forward while unhitching or while in storage. The plow should be parked on level ground to prevent the possibility of a tipover.

CAUTION! After parking the levee plow, always check to make sure that it can not be overturned either forward or backward accidentally.

ADJUSTMENTS: The AMCO levee plow can be easily adapted to manufacture a levee tailored to your needs. Simple adjustments can be made to control the width and pitch of the levee. Adjustments can be made to determine the size of the borrow furrow or to eliminate the borrow furrow. Also the cutting depth, cutting angle and number of passes used will affect the resulting levee. The following instructions are provided to aid you in selecting the adjustment and means of operation that will best suit your needs.

GANG ANGLE ADJUSTMENT: The gangs may be set at cutting angles from 18 degrees to 28 degrees depending on the need. Under normal conditions a setting somewhere between the extremes is advisable for best operation. More cutting angle will move the soil further and generally will improve penetration. Less angle will reduce the occurrence of large clods and will generally reduce "balling up" in wet conditions.

To decrease gang angle when in the levee building position, remove the angle adjusting pins underneath the ends of the main frame, shift the gangs forward and replace the pins at the desired setting. Make sure both gangs are pinned off at the same hole location. To increase gang angle move the gangs rearward. When in the levee-tear-down position the angle adjusting links will be pinned at the middle of the plow underneath the main frame.

CUTTING WIDTH: Use the ratchet jack on the levee plow side links to adjust cutting width. This will determine the overall width of the levee. Use the lower mounting lugs for 8-blade plows and the upper mounting lugs for 10-blade plows.

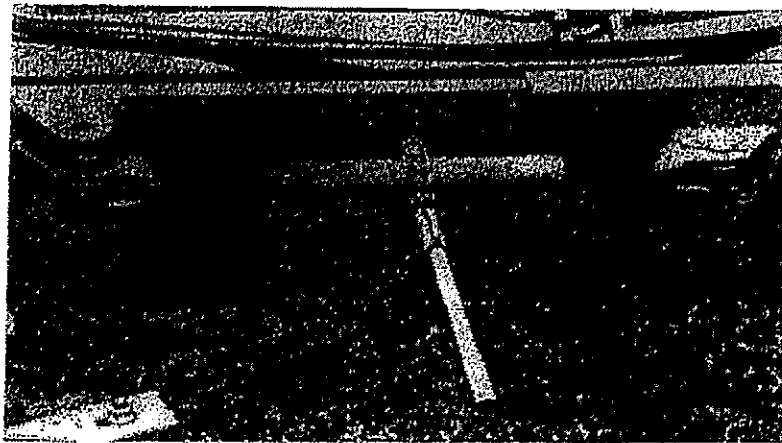

- M. After cleaning, checking and replacing all damaged parts, the gang should be assembled. Be sure the grease fittings in the bearing housings face to the rear. Be sure the snap ring in the bearing housing is turned toward the convex (back) side of the disk blade. The 1 1/2" gang bolt nut should be torqued to 1200 ft/lbs. The axle nut should be locked in place with the lock strap.
- N. After the gang is assembled it should be attached to the plow. The bearing risers should be carefully spaced to match the bearing housings. Poorly spaced bearing risers will overload the bearings and cause premature failure. The gang should be rotated 4 or 5 complete revolutions to be sure that all parts are aligned and the gang turns freely.
- O. The bearings should normally be greased each week or every 50 hours of use with a good grade of clean, number 2, lithium soap base grease. Grease more often under extreme conditions such as in wet ground, during hot, dry weather or when operating at high speeds.

It is essential that gang bolts be kept tight to prevent axle bending, blade breakage, spacer spool breakage and damage to other gang parts. Gang parts tend to wear on a bevel when the plow is operated with a loose gang bolt. This reduces the area of contact between mating gang parts. Therefore, it is often difficult to keep a gang bolt tight if it has been operated in a loose condition. After such a gang bolt has been properly torqued it should be retorqued after about 30 minutes of operation, again after 4 or 5 hours of operation and again after 8 to 10 hours of use. This will assure that proper gang bolt tension is maintained while the mating components are reseating. If the gang bolt will not stay tight, the gang should be completely disassembled and all parts carefully inspected. All damaged parts should be replaced before reassembling the gang.

5. **Scraper Repair:** Bent scraper bars or shanks should be replaced or straightened if possible. The blades can be replaced when they wear to the extent they are not performing properly. Keep the blades adjusted from 1/16" to 1/8" from the disk blades. The scrapers can be adjusted by loosening the mount bolt and sliding the scraper to the proper position then tightening the mount bolt. Additional adjustment can be obtained by loosening the scraper bar mount bolts and shifting the entire scraper bar. Do not allow the scraper blades to run on the spools as immediate damage to spool will occur.

6. Hydraulic Cylinder Repair.

- A. Remove hoses and fittings from cylinder.
- B. Remove cylinder from the plow and clean outside of cylinder.
- C. Dis-assemble cylinder by removing the rods and nut from end of cylinder rod. Slip piston and gland off cylinder rod.
- D. Carefully clean and inspect all parts for wear or damage. Small nicks, scratches or blemishes on rod and inside of barrel should be smoothed with fine steel wool or emory cloth. Replace parts that cannot be repaired.
- E. Remove all "O" Rings from piston and gland. Replace all seals with new parts.
- F. Assemble cylinder using care to prevent damage to "O" Rings and Seals. Make sure that all parts are cleaned and free of foreign matter before assembly.
- G. Replace the cylinder on the plow and attach hoses. Check cylinder for leaks.



GANG TILT ADJUSTMENT: Vertical gang tilt plays a very important roll in levee construction. For this reason, the AMCO levee plow is designed for "on the go" tilt adjustment. The gangs may be simultaneously tilted hydraulically from the tractor seat. A tilt indicator numbered to show hydraulic cylinder stroke is provided on the right hand gang which enables the operator to know exactly how much the gangs are tilted. Once a desirable sequence of settings for levee construction is obtained, it is no problem to duplicate the same sequence using the numbers on the indicator. When encountering wet soil, gang tilt can be reduced "on the go" to help prevent the gangs from balling up. Refer to the suggestions on hydraulic circuit trouble shooting as well as hydraulic assembly (page 20) and hydraulic maintenance (page 26).

LEVEE CONSTRUCTION: Depending on field conditions and management preference, different methods may be used for levee construction. Refer to the illustrations on page 23 for suggested methods for building rice levees. Points to remember when constructing levees:

1. Avoid plowing up large clods on the first pass by limiting depth of cut. The core of the levee should consist of fine soil particles to prevent water seepage.
2. Generally it is best to allow time for the soil to dry between passes. This will help in pulverizing the soil, thereby avoiding large clods which make a porous levee and a poor seed bed for rice planted on the levee.
3. Under normal conditions, no more than 3 passes will be required to form a levee. Depending on soil conditions and the depth of water to be held, a levee may require only one pass.
4. During the first pass the two middle disc blades do most of the work of forming the levee. By limiting gang tilt and primarily using the middle blades on subsequent passes a narrow, steep sloped levee can be built with a shallow borrow furrow on the sides. Here again, using the proper gang tilt for subsequent passes is important.
5. An optional feathering blade kit is available for AMCO levee plows to reduce the effects of a steep borrow furrow.
6. Sometimes a borrow furrow is desirable to aid in draining the rice field.
7. Sometimes it is good to pack the center of the levee with one or two passes of the tractor wheels to provide an impervious core before making the final pass.

LEVEE PLOW TEAR-DOWN INSTRUCTIONS

The AMCO Levee Plow can be easily converted for tearing down levees as described in the following steps.

STEP 1

Remove left hand and right hand scraper bars.

STEP 2

Remove adjusting links and mount on rear of mount bracket on gang frames.

STEP 3

Remove link anchor from the left hand and right hand holders, underneath the outside of the main frame, and insert the holders underneath the center of main frame.

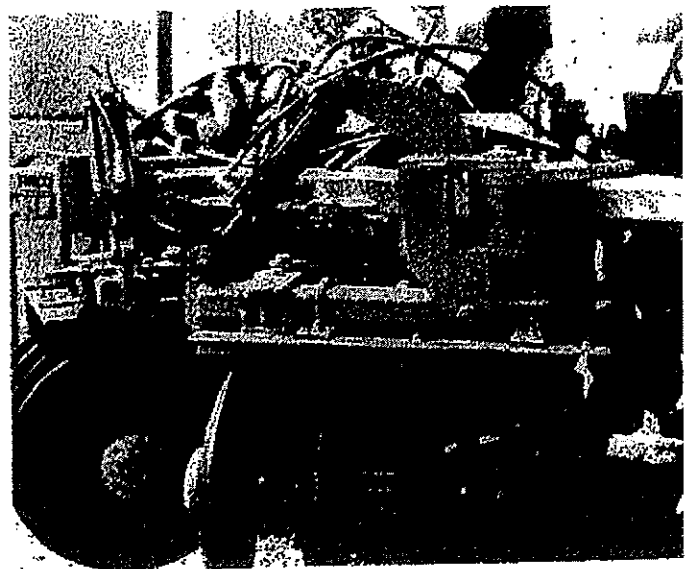
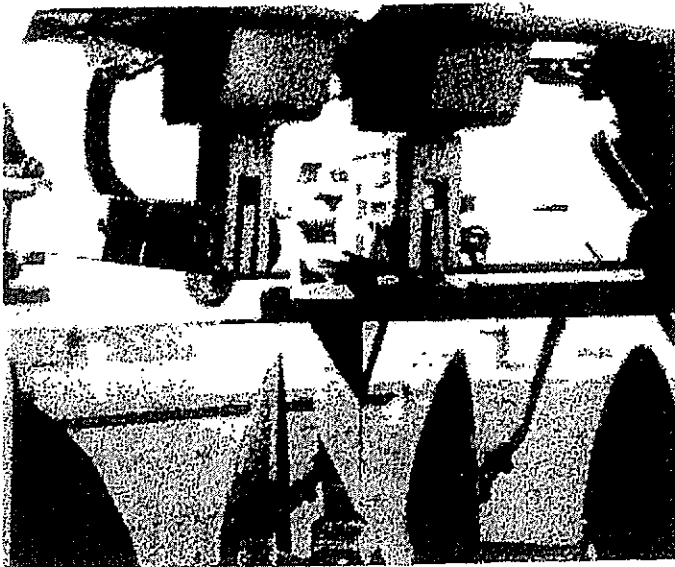

LIGHT SOIL

FIRST PASS:
 CYLINDERS FULLY RETRACTED.
 18 DEGREES-22 DEGREES CUTTING ANGLE.
 PLOW RUNNING 4"-6" DEEP
 BEGIN FORMING LEVEE.
 USE LOOSE, DRY SOIL PARTICLES
 TO PROVIDE DRY, IMPERVIOUS
 CORE.

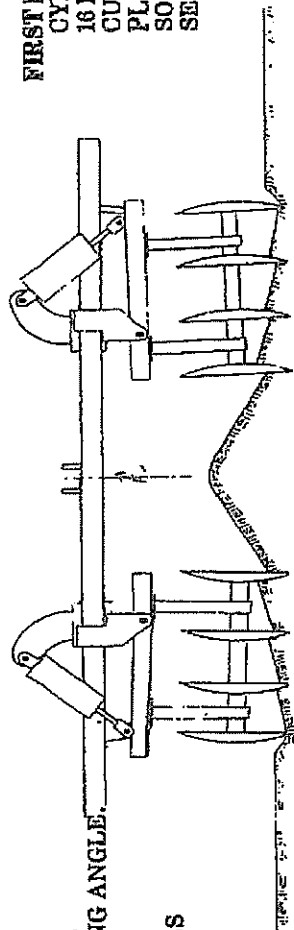

SECOND PASS:
 CYLINDERS EXTENDED 2" TO
 4". 18 DEGREES-22 DEGREES CUTTING
 ANGLE. CONTINUE FORMING LEVEE.
 IF NEEDED RUN REAR TRACTOR
 TIRE ON TOP OF LEVEE TO
 COMPACT LOOSE SOIL PRIOR
 TO LAST PASS.

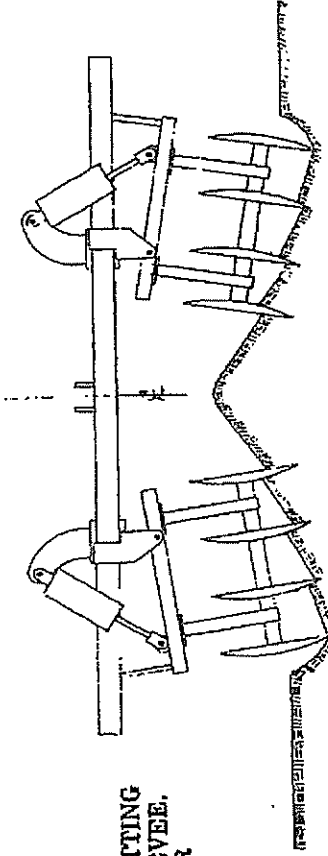

THIRD PASS:
 CYLINDERS EXTENDED 4" TO 8",
 15 DEGREES TO 20 DEGREES - 18
 DEGREES TO 22 DEGREES CUTTING
 ANGLE, CONTINUE FORMING
 LEVEE.

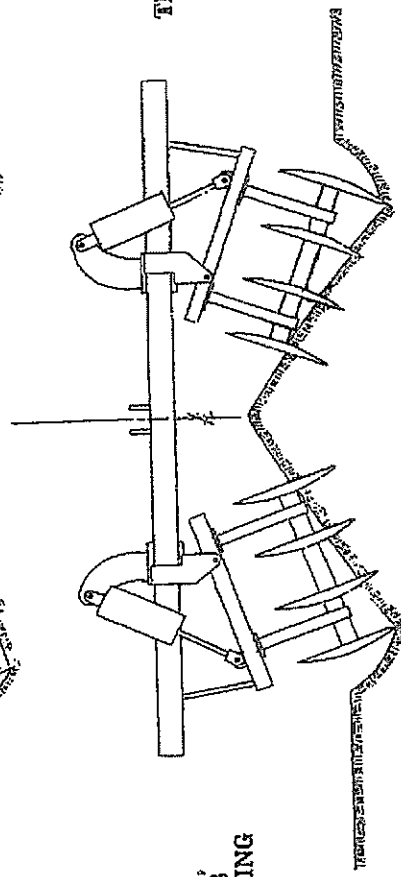

HEAVY SOIL

FIRST PASS:
 CYLINDERS FULLY RETRACTED.
 16 DEGREES TO 20 DEGREES
 CUTTING ANGLE.
 PLOW 3"-5" DEEP. LET
 SOIL SURFACE DRY BEFORE
 SECOND PASS.

SECOND PASS:
 CYLINDERS EXTENDED 2" TO 4"
 16 DEGREES TO 20 DEGREES
 CUTTING ANGLE.
 REDUCE DEPTH OF CUT OR
 DECREASE CUTTING ANGLE
 AS REQUIRED TO AVOID
 LEAVING LARGE WET CLODS.
 CONTINUE FORMING LEVEE.
 LET SOIL SURFACE DRY
 BEFORE THIRD PASS. IF
 NEEDED, RUN REAR TRACTOR
 TIRE ON TOP OF LEVEE TO
 COMPACT SOIL PRIOR TO
 LAST PASS.

THIRD PASS:
 CYLINDERS EXTENDED 4" TO
 8". 16 DEGREES TO 20 DEGREES
 CUTTING ANGLE.
 CONTINUE FORMING LEVEE.
 USE AN ADDITIONAL PASS
 AS REQUIRED TO FIRM AND
 SHAPE LEVEE.



Patented Concrete Roller
 Dynamically Balanced
 Verso 275, 300, 350

STEP 4

Swing gang around and lock adjusting links in link anchors underneath center of main frame.

STEP 5

At this point it may be required to adjust the inner and outer slide links to get desired cutting angle.

STEP 6

Take the left hand scraper bar and put on the right hand gang. Take the second scraper and scraper bolt from left side of scraper bar off and insert a 5/8 x 2 1/2 carriage bolt through the scraper, scraper bar and scraper bar support and tighten securely.

STEP 7

Take right hand scraper bar and put on the left hand gang. Take the second scraper and scraper bolt from right side of scraper bar off and insert the 5/8 x 2 1/2 carriage bolt through the scraper, scraper bar and scraper bar support and tighten securely.

NOTE: Keep the two 5/8 x 1 3/4 carriage bolts that were removed from the scrapers in a safe place for use when returning the plow to the levee building position.

Be sure to check torque on all bolts and see that pins are properly fastened. Check scraper location to insure proper operation.

Adjust the ratchet jack so that bumper washers between the two gangs do not hit in the field. This will cause excessive wear and damage to the washers and gang axle. The hydraulic cylinders should be extended slightly to level the gangs. (Set gauges on 1.)

HYDRAULIC TROUBLE SHOOTING

When first hooking up the hydraulic hoses to the tractor, the hydraulic cylinder rods should be fully extended, and the hydraulic valve on the tractor should be held open for at least one minute. This operation will fill the hydraulic cylinders and hoses with hydraulic fluid. Check the tractor hydraulic fluid level afterward, since the levee plow cylinders and hoses hold three quarts of fluid. Retract and extend the cylinders several times to purge the system of air.

Should the cylinders fail to operate together, check the hose installation as shown on page 7. The hose from the rod end of the 3 1/4" cylinder should connect to the butt end of the 3" cylinder.

It may be necessary to rephase the hydraulic cylinders during field use. The two cylinders can get out of phase if fluid leaks out of the system, and the gangs will not work together. Should this occur, fully extend or fully retract the cylinders holding the tractor hydraulic valve open for a few seconds. This will allow additional fluid to pass through the system replacing any fluid that may have leaked out. By occasionally, either fully retracting or fully extending the cylinders during field use, the system will be rephased continually thereby assuring that the gangs work together.

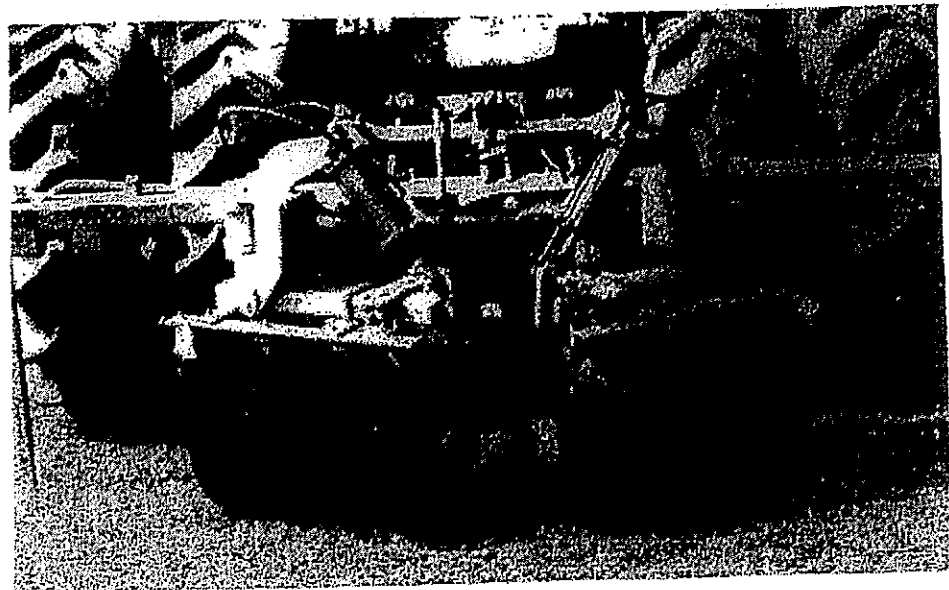

operating tips

OPERATING TIPS FOR LONG LIFE AND SATISFACTORY PERFORMANCE

1. Match the plow with the proper size tractor. Too much horsepower and speed will result in excessive maintenance cost.
2. Lubricate with clean grease at the recommended intervals.
3. Wash corrosive materials such as fertilizer and herbicides from the disk when it is not in use.
4. Insist on genuine AMCO replacement parts. Items such as bearings and blades look alike but are not as reliable as original equipment.
5. Never allow unsafe conditions or operating practices. Your safety is of prime importance.
6. Raise the Levee Plow by the 3 point hitch when turning around. Failure to do so will result in broken blades, bent axles, and excessive strain on the hitch and main frame.
7. Reduce operating speed in any areas containing stumps or rocks.

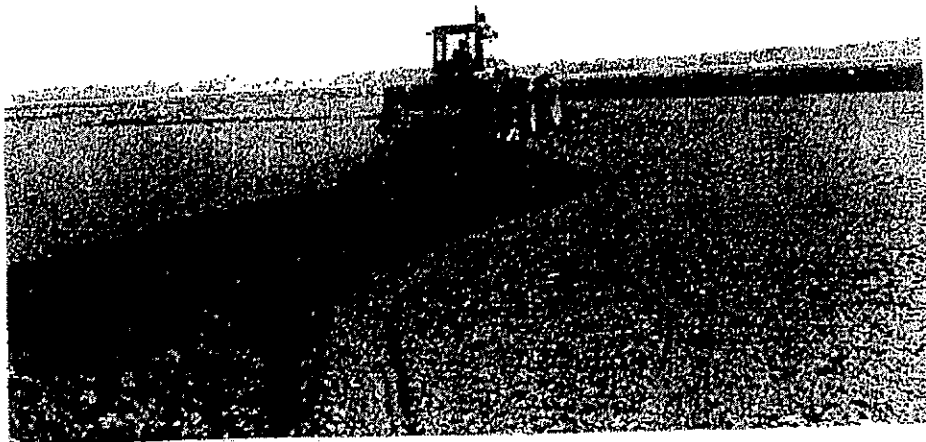

MOST OFTEN ENCOUNTERED DISK BLADE FAILURES

Most disk blade failures can be prevented by selecting the correct blade size and thickness for individual conditions when buying a disk. Reduction of speed in areas containing rocks and stumps will greatly lengthen the blade life. Keeping gang bolts properly torqued and raising the harrow while turning will also reduce disk blade breakage.

FIGURE 1 — Laminated Disc—defective steel. Eligible for warranty consideration.

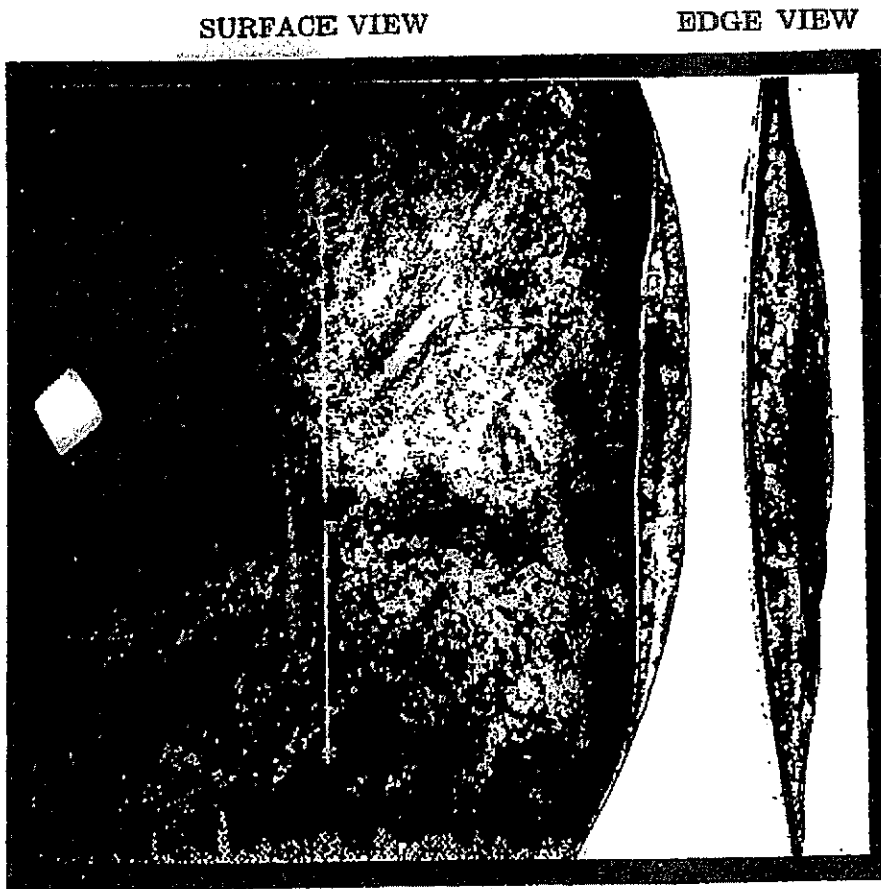

FIGURE 2 — Straight directional break caused by defective steel. Eligible for warranty consideration.



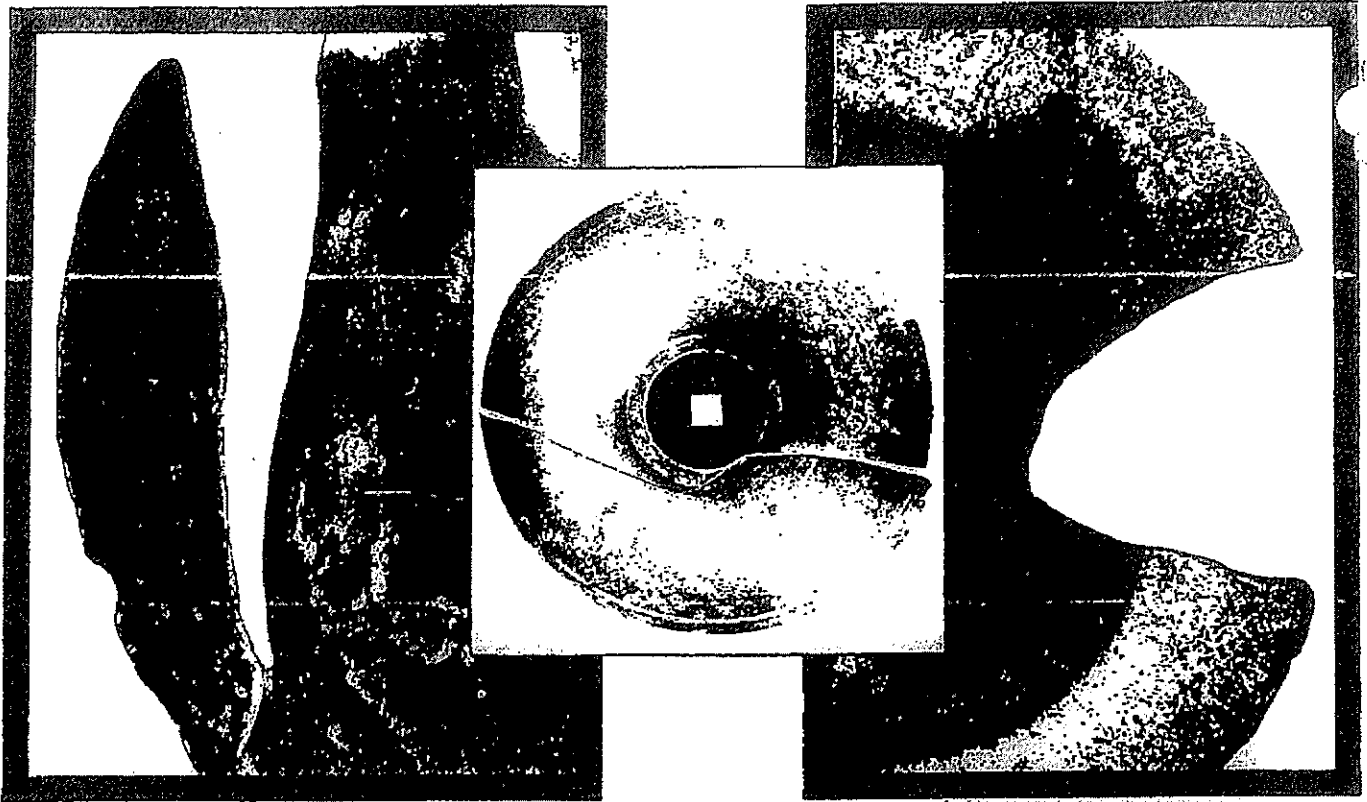

FIGURE 3, 4, 5 — Irregular breaks caused by contact against rocks or stumps. Not covered by warranty.



FIGURE 6 — Chipped or dented edges resulting from use in areas containing rocks or stumps. Not covered by warranty.



FIGURE 7 — Center broken out—Experience has shown that this is usually caused by loose bolts, excessive flexing or by contact with rocks and stumps. Not covered by warranty.



AMCO MANUFACTURING COMPANY

800 South Industrial Parkway P.O. Box 1107
Yazoo City, Mississippi (MS) 39194 USA
(662) 746-4464 Toll free 800-748-9022 Fax (662) 746-6825
www.amcomfg.com

INSERT

PARTS LIST FOR

LJ6 – 12 BLADE LEVEE PLOW

**AMCO LEVEE PLOW
LJ6 (12 BLADE)
GANG & FRAMES**

<u>Ref. No.</u>	<u>Part No.</u>	<u>Description</u>	<u>No. Req'd.</u>
1	20156	Assy. Gang Frame 3" x 5" x 42"	1
2	101336	Scraper Bar Support	2
3	11280	U-Bolt 7/8" Dia.	2
4	20163	Assy Rear Mount	1
5	10591	Hex Head Machine Bolt 7/8" x 6" NC, PL, Gr.5	4
6	10396	Lock Nut 7/8" NC, PL	8
7	16012A	Bearing Riser (PP)	2
8	9451	Gang Bolt 1-1/2" Sq. 60-1/4" 6 Blade	1
9	11647	Flange Lock Nut 5/8" NC, PL	9
10	10722	Carriage Bolt 5/8" x 2-1/2" NC, PL, Gr.5	2
11	10299	Lock Nut 5/8" NC, PL	4
12	20579	Grease Guard	4
12	102489	Wear Guard	4
13	10135	Carriage Bolt 5/8" x 1-3/4" NC, PL, Gr.5	11
14	11659	Steel Roll Pin 5/16" x 2-1/2"	1
15	9577A	Nut Gang Bolt PP Cast Steel	1
17	9578A	Bumper Washer	1
18	3255	Blade 24" x 1/4" Plain	1
18	3276	Blade 22" x 1/4" Plain	1
18	11588	Blade 20" x 1/4" Plain	1
18	9482	Blade 18" x 3/16" Plain	1
18	3055	Blade 16" 7 Ga. Plain	1
18	3266	Blade 14" 7 Ga. Plain	1
19	3278	10" x 11 Ga. Plain Back-up	3
20	17007	End Bell - Small	2
21	FB-09-0015	Sub Assy. Bearing and Housing	2
A	16003	Housing - Bearing	1
B	11503	Bearing 100mm GW211PP17	1
C	11064	Snap Ring	1
D	100104	Washer 100mm	2
E	12384	Grease Fitting 1/8" NPT Straight	1
22	17006	End Bell - Large	2
23	0523	Spacer Spool	3
25	1222A	End Gang Washer	1
26	10710	Carriage Bolt 1/2" x 2" NC, PL	1
27	10395	Lock Nut 1/2" NC, PL	1
28	100099	Spacer Plate	1
29	100098	Bearing Plate	1
30	5622A	Lock Plate	1
31	10489	Nut Gang Bolt 1-1/2" NF	1
32	102511	Scraper Bar 3" x 2" x 3/8" Angle - 64-9/32"	1
33	20068	Assy. Scraper - RH	5
34	20069	Assy. Scraper - LH	5
A	101049	Scraper Shank	1
B	101019	Scraper Blade	1
C	10832	Cut Washer 1/2" PL	2
D	10395	Lock Nut 1/2" NC, PL	2
E	11652	Machine Bolt 1/2" x 1-1/4" NC(PLT)	2
F	101173	Scraper Shank	1
35	20112	Assy. Scraper Shank (Special) - RH	1
36	20113	Assy. Scraper Shank (Special) - LH	1

LJ6 [12 BLADE] GANGS & FRAMES

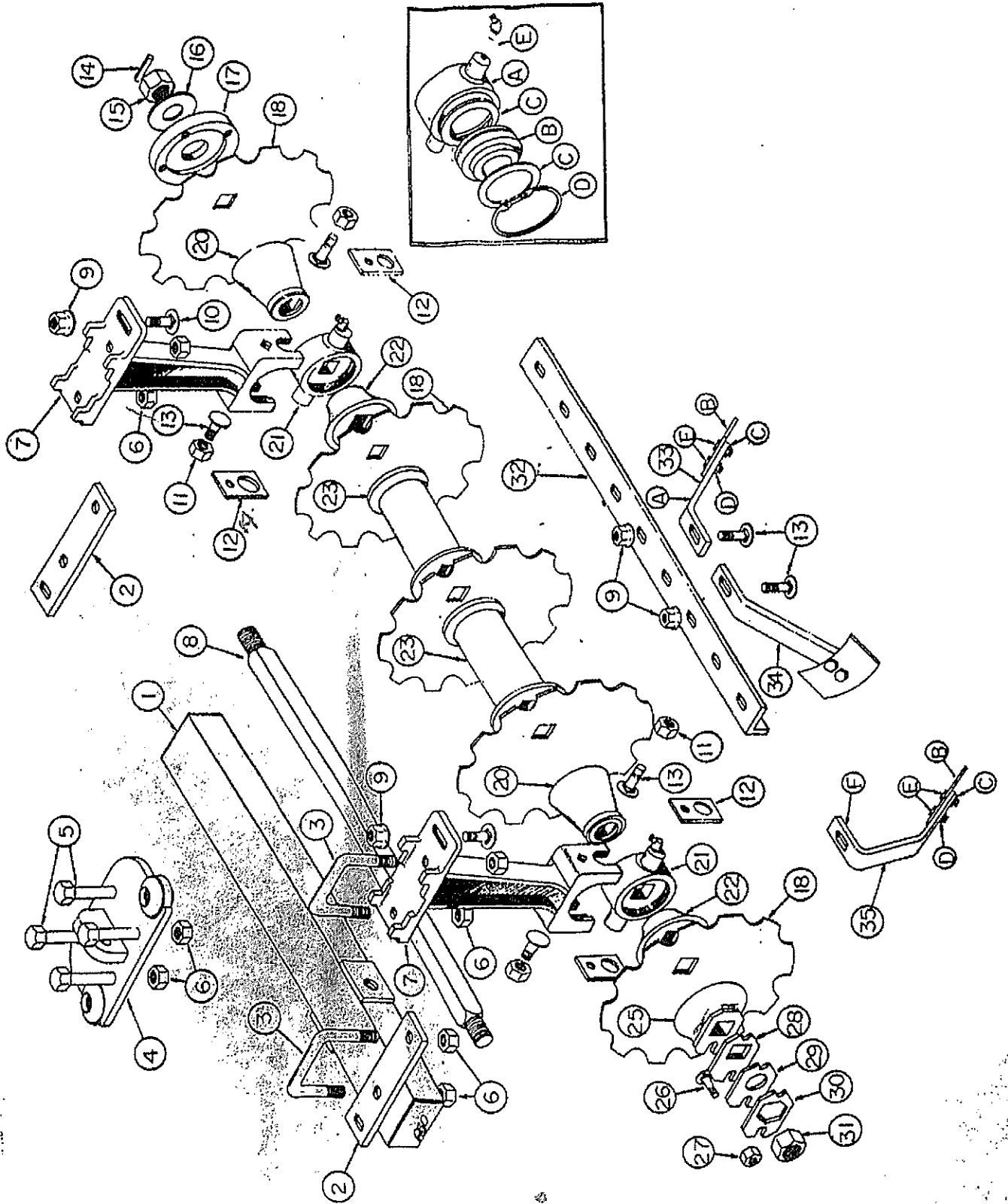





4
1
2



1
2
3





5
4
3
2



1
2
3
4

